

# COMPLEX MEASURING TASKS BROUGHT STRAIGHT TO THE POINT. **MILLIMAR**



The latest information on MILLIMAR products can be found on our website:

**[www.mahr.com](http://www.mahr.com), WebCode 153**

▶ | The requirements for electrical length measuring instruments are almost as broad as their scope of application. Reliability, precision as well as simple operation are the major demands, Millimar compact and column measuring instruments fulfill all these demands and requirements.

Millimar probes are the most influential components of a measurement chain. Their characteristics determine the quality of the entire measurement; depending upon the type of application we have the corresponding probe for your requirements. For example; a Millimar Inductive Probe: robust, versatile and has an attractive price, or a Millimar Incremental Probe which is ideal over a large measuring range and has a small linearity error over the entire measuring range. | ◀

**Call Rapp Industrial for your discounted pricing 724-789-7853 / 888-789-7288. Email us - [sales@rappindustrialsales.com](mailto:sales@rappindustrialsales.com)**

## ▶ | Millimar. Electrical Length Measuring Instruments, Air Gaging and Engineered Solutions

Overview	
Electrical Length Measuring Instruments	7- 2
Overview	
Inductive Probes Program	7- 4
Millimar P1300	7- 6
Millimar P2001 / P2004 / P2010 / P2104	7-10
Millimar 1301 / 1303 / 1304 K / 1318 / 1340	7-14
Millimar Lever Type Gage Heads EHE	7-16
Millimar Spring (Pantograph) Type Gage Heads	7-18
Overview	
Evaluation Instruments	7-20
Millimar 1200 IC / 830 / 832 / C1208 / C 1216 / C 1245 / 1240	7-22
Millimar S 1840	7-30
Millimar X 1715 / X 1741	7-31
Millimar 1901 TA	7-33
Millimar G1275	7-34
Overview	
Electronic Levels	7-36
Air Gaging Metrology	7-40
Overview	
Air Evaluation Units	7-42
Air Gages	7-55
Engineered Solutions	7-66

# Millimar. Electrical Length Measuring Instruments

## OVERVIEW

### Evaluation Instruments



C 1216



C 1245

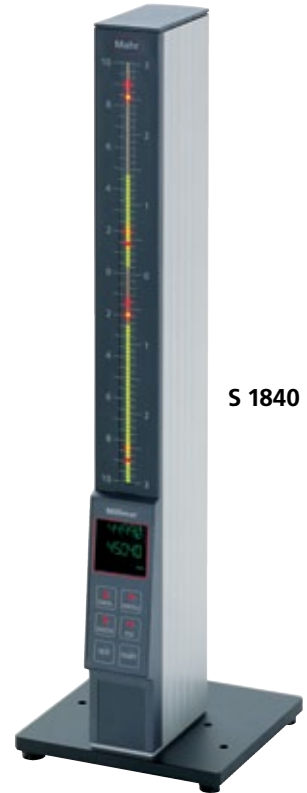

S 1840

- Compact, handy and simple to operate
- Extremely precise and easy to read due to the large clearly defined analog or digital display
- Single, sum and differential measurement; limit switches and extreme value memories
- Highly accurate, long term stability and insensitive to environmental influences
- Good zero stability even when changing the measuring range
- Short response time ideal for assessment of fast processes
- Analog or digital display
- Connect to a controller or a computer via the digital output
- Analog output (optional)

### Inductive Probes

- Large linearity range, strong output signal and insensitive to interference
- Precise measuring spindle and lever, frictionless ball or spring bearing for the highest resolution with the lowest hysteresis
- Cable is plugged into the probe allowing quick and simple maintenance (P1300)
- Robust construction for use on the shop floor; further models for all applications are available.



P1300 M



P2004 M

# Millimar. Electrical Length Measuring Instruments

## APPLICATIONS WITH INDUCTIVE PROBES

### Single measurement with one probe

Indicating instrument instantly displays the measured value.

- Used for all kinds of direct measurements on cylindrical and flat work pieces
- Applied in the same way as with digital / dial indicators, digital / dial comparators or test indicators

#### Thickness measurement

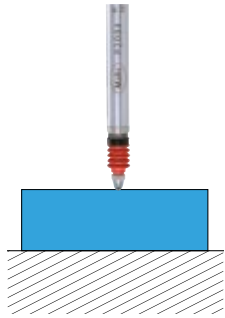

#### Radial run-out

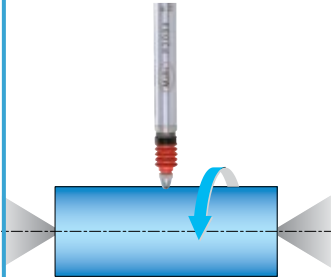

#### Axial run-out

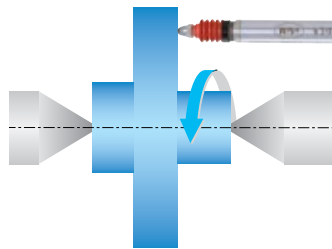

### Sum measurement with 2 probes

Indicates the sum of deviation (total composite error) acquired from 2 probes irrespective of the form, support and concentricity deviation.

#### Thickness measurement

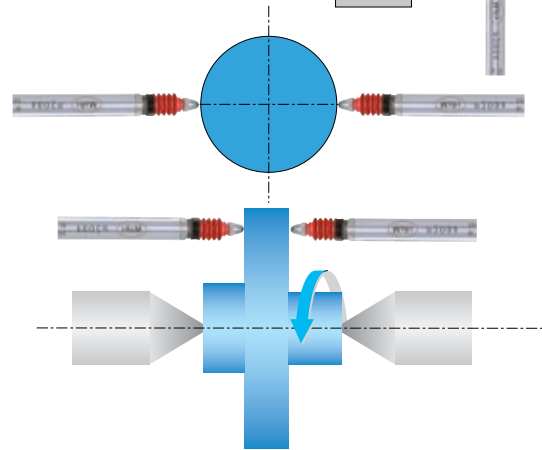
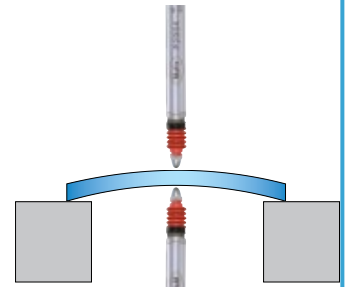

### Difference measurement with 2 probes

Shows the difference between the measured values acquired by 2 probes irrespective of the absolute dimension of the test piece. This is particularly suitable for dimensional comparison of two test points.

#### Form measurement of wedges, cones

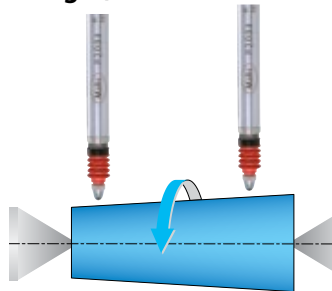

#### Height difference between 2 steps

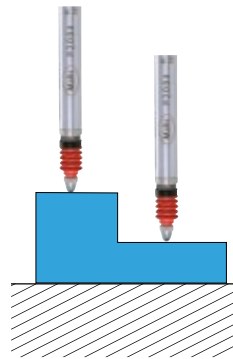

#### Perpendicularity measurement

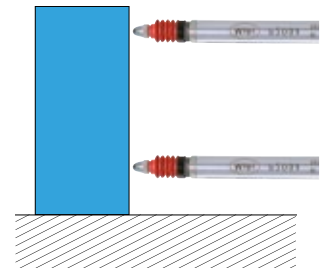

#### Concentricity measurement on 2 shaft diameters

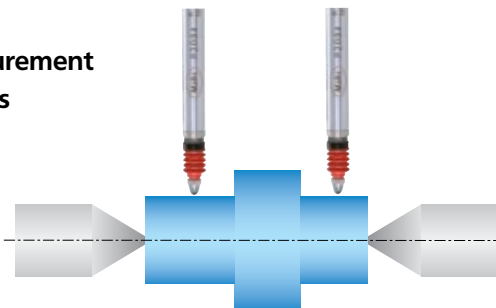

# Millimar. Electrical Length Measuring Instruments

## INDUCTIVE PROBE PROGRAM

### P1300-Series (Mahr-Half bridge)



P1300 A



P1300 B

- Available in Mahr and Tesa compatibilities
- Well-proven and established Mahr-Half Bridge technology
- Easy to service: cable and probe can be separated via the plug-in connector
- Simple to change to pneumatic lifting
- Measuring spindle runs in rotary stroke bearings

Page 7-6

### P2000-Series



P2001



P2004



P210 A



P2104 A

- Available in all prominent compatibilities (Mahr, Mahr-Federal, Tesa, Marposs)
- Wide product spectrum; measuring ranges from 1 to 10 mm plus models with a compressed air (pneumatic) lifter or with vacuum retraction
- With rotary stroke bearings (except P2001)
- High linearity over the total measuring range
- Excellent electromagnetic shielding (EMC)
- All probes (except P2001) can be easily converted from axial to radial by mounting a slip on cap, included in the scope of supply

Page 7-10

### 1301 / 1303 / 1304 K / 1318 (Mahr-LVDT) / EHE-Series (Federal-LVDT)



1301



1303



1304 K



1318



EHE-2056

- Extremely robust in all operating conditions; measuring system is offset to guide and mounting shank
- Excellent clamping characteristics
- Measuring spindle runs in rotary stroke bearings (except 1318)
- Measuring spindle can be lifted with a cable release (1301/1303)
- Gaging pressure is less than 4g / .14 oz in either direction, with a change of less than 0.1 g per 25 µm / .0001" of contact travel and linearity of 0.1% over the full range  $\pm 0.250 \text{ mm} \pm .010''$ , also clutch-mounted contact swivels through 280° arc for easy positioning (EHE-Series)

Page 7-14

### 1340 Mahr High Precision Probe



1340

- To obtain the best results use in conjunction with Millitron 1240
- Unprecedented measuring accuracy and minimum linearity error < 0.01 %, i.e. 0.4 µm over the total measuring range

Page 7-14

## General Technical Data of Inductive Probes

The measuring principle of inductive probes is based on the change of position of the magnets conductive core moving within a coil system, generally this is distinguished between a half bridge and LVDT's.

The Mahr P2000 series of probes applies a high linear, patented VLDT transducer which is similar to an LVDT transducer. This also operates according to a differential transformer principle.

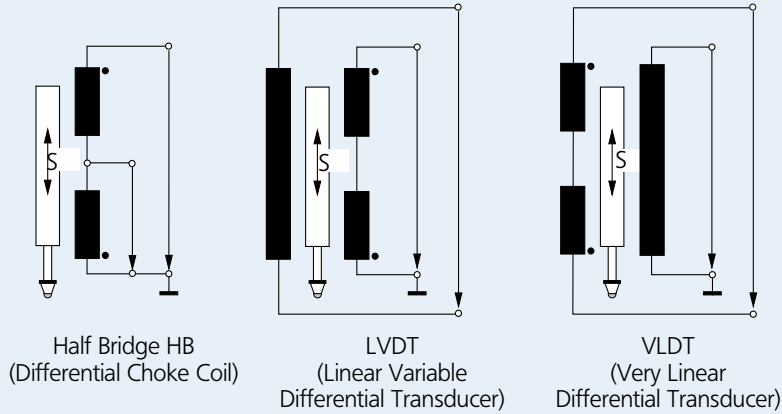

### Electrical specification of various compatibilities

		Type	Mahr	Tesa	Marposs	Mahr-Federal
Carrier frequency	KHz		19.4	13	7.5	5
Sensitivity	mV/V/mm	P2001				
		P2004	192	73.75	115	78.74
		P2104				
		P1300	192	73.75	—	—
		1301				
		1303	192	—	—	—
		1304 K				
		1318				
		P2010	19.2	29.5	11.5	7.874
Amplitude	Veff		5	3	3.5	2

### Schematic drawings of Mahr input amplifiers according to the various compatibilities

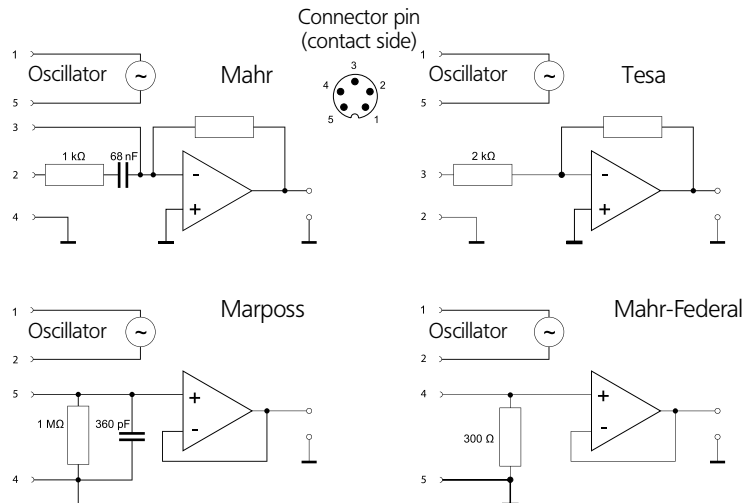

# Millimar. The Plug and Play Probe

## THE INDUCTIVE PROBE MILLIMAR P1300

► | The Plug and Play Probe: Cable and probe can be separated with the plug-in connector. High linearity due to sensitivity compensation in the probe. | ◀

**High linearity** due to the probe being able to compensate sensitivity.

**Pneumatic Lifter** can be fitted to any standard probe (with standard accessories). Simply fasten and unfasten an air hose.



**Rotary stroke bearings** thus insensitive to lateral forces acting upon the spindle

Especially suited for use in critical manufacturing environments. Probe and cable connector are water proof **IP64** according to IEC 60529



Sealing bellow is made from Viton which has a **excellent chemical resistance**.

Code Initial	<b>IP</b>	International Protection
First Numeral	<b>6</b>	Dust-tight
Second Numeral	<b>4</b>	Protected against splash water from all directions





**Extremely easy to service**

Cable and probe can be separated via the plug-in connector.



**Advantages of a probe with a plug-in connector:**

Service incident	P1300	Standard Probe
<p><b>Cable break</b></p> 	<p>Only the cable has to be replaced.</p> <p><b>Advantage:</b></p> <ul style="list-style-type: none"> <li>a) Shorter downtime of manufacturing equipment as the probe does not need to be newly installed and adjusted.</li> <li>b) Inexpensive, as only the cable has to be replaced and not the complete probe.</li> </ul>	<p>The complete probe must be removed from the fixture and replaced.</p> <p><b>Disadvantage:</b></p> <ul style="list-style-type: none"> <li>a) Longer downtime as the probe must be newly installed, set-up and adjusted.</li> <li>b) Expensive as the complete probe must be replaced.</li> </ul>
<p><b>Defective probe</b> e.g. collision with workpiece</p> 	<p>Only the probe has to be replaced.</p> <p><b>Advantage:</b></p> <p>The cable does not need to be removed from the cable guide or the cable harness</p>	<p>The complete probe including the cable must be replaced.</p> <p><b>Disadvantage:</b></p> <p>The cable must be dismantled from the cable guide or the cable harness.</p>



## Inductive Probe Millimar P1300 M / T Half Bridge

### Features

- Supplied with:  
Inductive Probe P1300  
Connection cable 2.5 m  
Screwed sealing plug  
Hose connector for compressed air  
Open-ended spanner  
Operating instructions

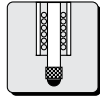

Cable and probe can be separated with the plug-in connector.



### Technical Data

Probe type	P1300 MA	P1300 TA	P1300 MB	P1300 TB
Measuring range	$\pm 2.0 \text{ mm} / \pm 0.079''$			
Distance of lower stop <sup>1)</sup>	$- 2.2 \dots 0 \text{ mm} / - 0.09 \dots 0''$			
Distance of upper stop <sup>1)</sup>	$+ 2.2 \dots 4.4 \text{ mm} / + 0.09 \dots 0.173''$			
Lifter/Retraction	Vacuum Lifter (Standard option)		Compressed Air Retraction (max. 1 bar)	
Measuring force at electrical zero point	$0.75 \text{ N} / \pm 0.15 \text{ N}^2$		depending upon air pressure	
Increase in measuring force	$0.3 \text{ N} / \text{mm}$		-	
Sensitivity deviation	$0.3 \%$			
Repeatability $f_w$	$0.1 \mu\text{m} / 4 \mu\text{in}$			
Hysteresis $f_u$	$0.5 \mu\text{m} / 20 \mu\text{in}$			
<b>Linearity deviation with revised sensitivity</b>				
within range $\pm 0.5 \text{ mm}$	$0.4 \mu\text{m} / 16 \mu\text{in}$	$1.0 \mu\text{m} / 40 \mu\text{in}$	$0.4 \mu\text{m} / 16 \mu\text{in}$	$1.0 \mu\text{m} / 40 \mu\text{in}$
within range $\pm 1.0 \text{ mm}$	$1.5 \mu\text{m} / 60 \mu\text{in}$	$3.0 \mu\text{m} / 120 \mu\text{in}$	$1.5 \mu\text{m} / 60 \mu\text{in}$	$3.0 \mu\text{m} / 120 \mu\text{in}$
within range $\pm 2.0 \text{ mm}$	$3.0 \mu\text{m} / 120 \mu\text{in}$	not specified	$3.0 \mu\text{m} / 120 \mu\text{in}$	not specified
Protection class according to IEC 60529	IP64			
Length of cable	$2.5 \text{ m} / 8 \text{ ft}$ (detachable)			
Compatibility - Half Bridge	Mahr	Tesa	Mahr	Tesa
<b>Order no.</b>	<b>4400180</b>	<b>4400190</b>	<b>4400181</b>	<b>4400191</b>

<sup>1)</sup> Relative to the electrical zero point. Adjustable; lower and upper stops are simultaneously adjusted

<sup>2)</sup> Measuring force springs are interchangeable, following measuring force springs are available (0.25; 0.5; 1; 1.25; 1.5 N)

## Inductive Probe Millimar P1300 M / T Half Bridge

- 1 Connection jack for an evaluation instrument
- 2 Connecting plug for the probe
- 3 Socket
- 4 Screw sealing plug SW 4.6
- 5 Hose connector for compressed air (external diameter 3 mm)
- 6 Mounting shank
- 7 Locking nut
- 8 Sealing bellows
- 9 Contact point 901 H
- 10 Preferred clamping area

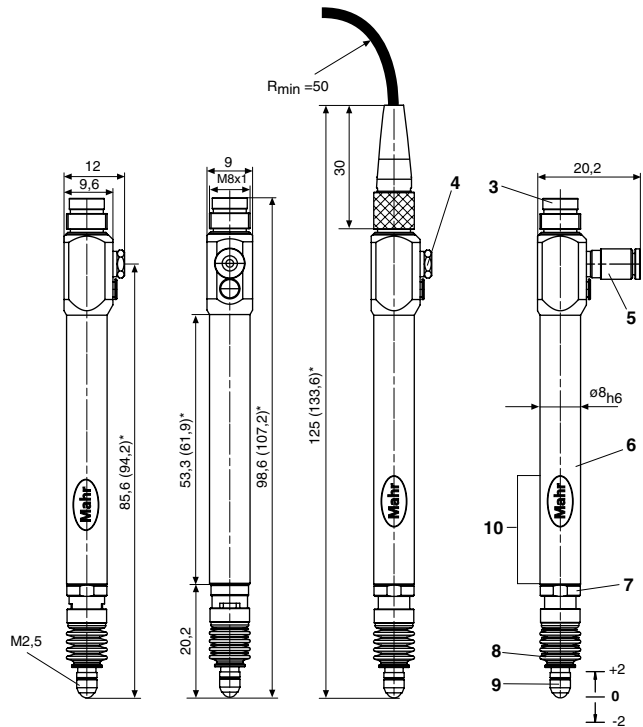
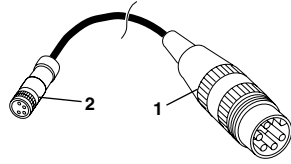

\* Values shown in brackets apply to Tesa-compatibility

## Individual Components and Accessories P1300



P1300 .. A



P1300 .. B



Connector for the air hose (90°)



Connection cable 2.5 m / 8 ft

	Order no.
<b>P1300 MA</b> without cable	<b>4400182</b>
<b>P1300 MB</b> without cable	<b>4400183</b>
<b>P1300 TA</b> without cable	<b>4400192</b>
<b>P1300 TB</b> without cable	<b>4400193</b>
<b>Hose connector</b> for compressed air 90°	<b>4400238</b>
<b>Cable</b> for P1300 - 90°      2.5 m / 8 ft	<b>4885334</b>
<b>Cable</b> for P1300 - 90°      5 m / 16 ft	<b>4885335</b>
<b>Cable</b> for P1300 - 90°      10 m / 32 ft	<b>4885336</b>
<b>Cable</b> for P1300              2.5 m / 8 ft	<b>4885220</b>
<b>Cable</b> for P1300              5 m / 16 ft	<b>4885259</b>
<b>Cable</b> for P1300              10 m / 32 ft	<b>4885260</b>

	Order no.
<b>Sealing bellows</b> for	
P1300 .. A	<b>7021546</b>
P1300 .. B	<b>7028220</b>
<b>Measuring force springs<sup>1)</sup></b> for P1300 .. A	
0.25 N	<b>7026827</b>
0.50 N	<b>7026827</b>
0.75 N	<b>7026828</b>
1.00 N	<b>7026849</b>
1.25 N	<b>7025579</b>
1.50 N	<b>7025505</b>

<sup>1)</sup> All measuring forces (except 0.25 N) including the sealing bellows have a measuring spring force of ca 0.25 N at zero point.

## Inductive Probe Millimar P2000-Series

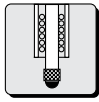

### Technical Data

Probe type	P2001	P2004	P2004 A	P2004 B
Measuring range	± 0.5 mm / ± 0.020"		± 2.0 mm / ± 0.079"	
Distance of lower stop <sup>1)</sup>	–		– 2.2 ... 0 mm / –0.09 ... 0"	
Distance of upper stop <sup>1)</sup>	–		+2.2 ... 4.4 mm / 0.09 ... 0.173"	
Lifter/Retraction	–	–	Vacuum lifter	Compressed air (max. 1 bar) depending on air pressure
Measuring force at the electrical zero point	0.75 N ± 0.15 N	0.75 N ± 0.15 N <sup>2)</sup>	0.75 N ± 0.15 N <sup>2)</sup>	–
Increase in measuring force	0.1 N / mm	0.2 N / mm	0.2 N / mm	–
Sensitivity deviation	0.3 %		0.3 %	
Repeatability f <sub>w</sub>	0.15 µm / 6 µin		0.1 µm / 4 µin	
Hysteresis f <sub>u</sub>	0.2 µm / 8 µin		0.5 µm / 20 µin	
<b>Linearity deviation with corrected sensitivity</b>				
within range ± 0.1 mm	0.6 µm / 24 µin		–	
within range ± 0.5 mm	1.5 µm / 60 µin		0.4 µm / 16 µin	
within range ± 1.0 mm	–		1.5 µm / 60 µin	
within range ± 2.0 mm	–		3.0 µm / 120 µin	
Protection class acc. to DIN VDE 0470 Part 1 / IEC 60529	IP40		IP64	
Cable length	2.5 m / 8 ft <sup>3)</sup>		2.5 m / 8 ft <sup>3)</sup>	
<b>Order no.</b>	<b>P2001</b>	<b>P2004</b>	<b>P2004 A</b>	<b>P2004 B</b>
Compatibility - Mahr	5323040	5323010	5323020	5323030
Compatibility - Tesa	5323041	5323011	5323021	5323031
Compatibility - Marposs	5323043	5323013	5323023	5323033
Compatibility - Federal	5323044	5323014	5323024	5323034

<sup>1)</sup> Relative to the electrical zero point. Adjustable; lower and upper stops are simultaneously adjusted

<sup>2)</sup> Measuring force springs are interchangeable, additional measuring force springs are available (0.25; 0.5; 1; 1.25; 1.5 N)

<sup>3)</sup> Extension cables are available, see accessories

## Inductive Probe Millimar P2000-Series

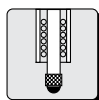

### Technical Data

Probe type	P2010*	P2010 A*	P2010 B*	P2104 A	P2104 B
Measuring range	± 5.0 mm / ± <b>0.197"</b>			± 2.0 mm / ± <b>0.079"</b>	
Distance of lower stop	- 5.3 mm / - <b>.20"</b>			- 2.2 ... 0 mm / - <b>0.09 ... 0"</b> <sup>1)</sup>	
Distance of upper stop	+ 5.3 / + <b>.20"</b>			8.4 ... 10.4 mm / - <b>0.33 ... 0.41"</b> <sup>1)</sup>	
Lifter/Retraction	–	Vacuum lifter	Compressed air (max. 1 bar)	Vacuum lifter	Compressed air (max. 1 bar)
Measuring force at the electrical zero point	0.75 N ± 0.15 N <sup>2)</sup>	0.75 N ± 0.15 N <sup>2)</sup>	depending on air pressure	0.75 N ± 0.15 N <sup>2)</sup>	depending on air pressure
Increase in measuring force	0.1 N / mm	0.1 N / mm	–	0.1 N / mm	–
Sensitivity deviation	0.3 %				
Repeatability $f_w$	0.2 µm / <b>8 µin</b>				
Hysteresis $f_u$	1 µm / <b>40 µin</b>			0.5 µm / <b>20 µin</b>	
<b>Linearity deviation with corrected sensitivity</b>					
within range ± 0.5 mm	–			0.5 µm / <b>20 µin</b>	
within range ± 1.0 mm	–			2.0 µm / <b>80 µin</b>	
within range ± 2.0 mm	4.0 µm / <b>160 µin</b>			4.0 µm / <b>160 µin</b>	
within range ± 5.0 mm	20.0 µm / <b>800 µin</b>			–	
Protection class acc. to DIN VDE 0470 Part 1 / IEC 60529	IP64			IP64	
Cable length	2.5 m / 8 ft <sup>3)</sup>			2.5 m / 8 ft <sup>3)</sup>	
<b>Order no.</b>	<b>P2010</b>	<b>P2010 A</b>	<b>P2010 B</b>	<b>P2104 A</b>	<b>P2104 B</b>
Compatibility - Mahr	<b>5324010</b>	<b>5324020</b>	<b>5324030</b>	<b>5324070</b>	<b>5324080</b>
Compatibility - Tesa	–	<b>5324021</b>	<b>5324031</b>	<b>5324071</b>	<b>5324081</b>
Compatibility - Marposs	–	<b>5324023</b>	<b>5324033</b>	<b>5324073</b>	<b>5324083</b>
Compatibility - Federal	–	<b>5324024</b>	<b>5324034</b>	<b>5324074</b>	<b>5324084</b>

\* Output  $1/10$  sensitivity

<sup>1)</sup> Relative to the electrical zero point. Adjustable; lower and upper stops are simultaneously adjusted

<sup>2)</sup> Measuring force springs are interchangeable, additional measuring force springs are available (0.25; 0.5; 1; 1.25; 1.5 N)

<sup>3)</sup> Extension cables are available, see accessories

## Inductive Probe Millimar P2000-Series

### P2001

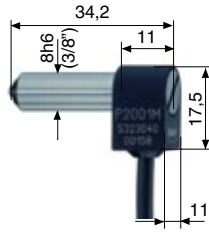

### P2004

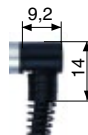
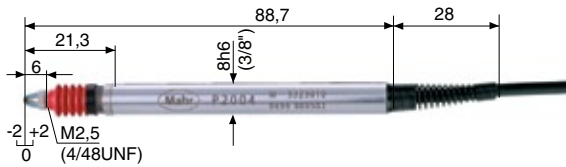

With the supplied slip-on cap, the cable can be flexed to 90° (vertical to horizontal)

### P2004 A / P2004 B

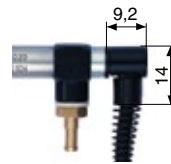
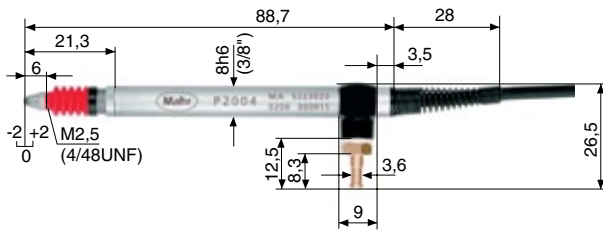

With the supplied slip-on cap, the cable can be flexed to 90° (vertical to horizontal)

### P2010

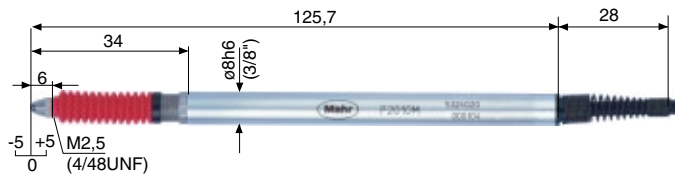

With the supplied slip-on cap, the cable can be flexed to 90° (vertical to horizontal)

### P2010 A / P2010 B

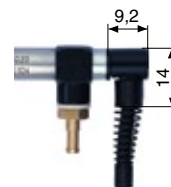
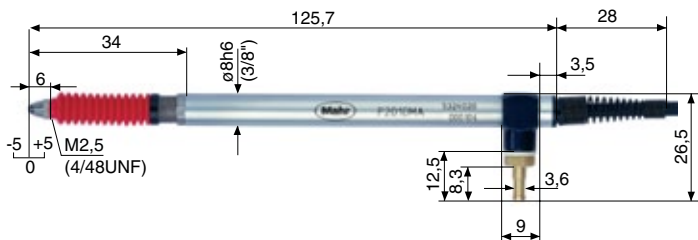

With the supplied slip-on cap, the cable can be flexed to 90° (vertical to horizontal)

### P2104 A / P2104 B

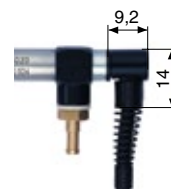
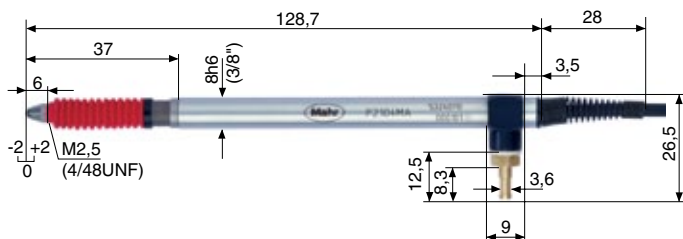

With the supplied slip-on cap, the cable can be flexed to 90° (vertical to horizontal)

Values shown in brackets apply to Federal-compatibility

## Accessories

Extension cables		Mahr M	Tesa T	Marposs U	Mahr Federal F
Length	Description	Order no.	Order no.	Order no.	Order no.
2.5 m / 8 ft	C 2025	<b>5323130</b>	<b>5323131</b>	<b>5323133</b>	<b>5323134</b>
5 m / 16 ft	C 2050	<b>5323140</b>	<b>5323141</b>	<b>5323143</b>	<b>5323144</b>
7.5 m / 24 ft	C 2075	<b>5323150</b>	<b>5323151</b>	<b>5323153</b>	<b>5323154</b>
10 m / 32 ft	C 2100	<b>5323160</b>	<b>5323161</b>	<b>5323163</b>	<b>5323164</b>

	Order no.		Order no.
<b>Measuring force springs<sup>1)</sup> for P2004 and 2004 A</b>		<b>Measuring force springs<sup>1)</sup> for P2010 and P2010 A</b>	
0.25 N	<b>7026827*</b>	0.25 N	<b>7028212*</b>
0.50 N	<b>7026827</b>	0.50 N	<b>7028212</b>
0.75 N	<b>7026828</b>	0.75 N	<b>7027764</b>
1.00 N	<b>7026849</b>	1.00 N	<b>7028213</b>
1.25 N	<b>7025579</b>	1.25 N	<b>7028214</b>
1.50 N	<b>7025505</b>	1.50 N	<b>7028215</b>
<i>1) All measuring forces (except 0.25 N) include the rubber sealing bellows have a measuring spring force of ca. 0.25 N in zero position.</i>		<i>1) All measuring forces (except 0.25 N) include the rubber sealing bellows have a measuring spring force of ca. 0.25 N in zero position.</i>	
* Remove rubber sealing bellows		* Remove rubber sealing bellows	

	Order no.		Order no.
<b>Measuring force springs<sup>1)</sup> for P2104 A</b>		<b>Rubber sealing bellows for</b>	
0.25 N	<b>7028212</b>	2004, 2004 A	<b>7021546</b>
0.50 N	<b>7027764</b>	2004 B	<b>7028220</b>
0.75 N	<b>7028213</b>	2010, 2010 A, 2104 A	<b>7027758</b>
1.00 N	<b>7028214</b>	2010 B, 2104 B	<b>7028221</b>
1.25 N	<b>7028215</b>		
<i>1) All measuring forces include the rubber sealing bellows</i>			

<b>Pneumatic Lifter 1340/1</b>	for connection with 1 Probe	<b>5313420</b>
<b>Pneumatic Foot Switch 1340/1F</b>	for connecting max. 4 Probes, types 1340, P2004xA, P2010xA, P2104xA, 1300 A, 1310 A	<b>5313419</b>

## Temperature specifications

Temperature coefficient ftT	0.15 $\mu\text{m} / ^\circ\text{C}$
Working temperature range	+ 10 ... + 55° C (+ 50 ... + 131° F)
Operating temperature range	- 10 ... + 80° C (+14 ... + 176° F)
Information regarding chemical resistance	Resistant against oil, gasoline (petrol), water, alipate. Moderate against acids, alkaline solutions, solvents, ozone

Inductive Probe Millimar 1301 / 1303 / 1304 K / 1318 / 1340

M



Technical Data

Probe type	1301	1303	1304 K	1318	1340
Measuring range	± 1.0 mm / ± .039"		± 1.0 mm / ± .039"	-0.3 ... +1.0 mm / -.012 ... +.039"	± 2 mm / ± .079"
Distance of lower stop <sup>1)</sup>	-1.1 ... 0 mm / -.043 ... 0"		1.1 mm / -.043"	-0.37 mm / -.0146"	-2.2 mm / -.09" (adjustable)
Distance of upper stop <sup>1)</sup>	+2.7 mm / +.106"		+1.1 mm / +.043"	+1.6 mm / +.063"	+3.0 mm / +.118"
Lifter/Retraction	Cable release		-	-	pneumatic
Measuring force at the electrical zero point	0.75 N ± 0.15 N		0.75 N ± 0.15 N	0.25 N ± 0.05 N	0.75 N ± 0.15 N
Increase in measuring force	0.4 N / mm		0.15 N / mm	0.04 N / mm	0.08 N / mm
Sensitivity deviation	0.3 %		1.0 %	0.5 %	0.3 %
Repeatability f <sub>w</sub>	0.1 μm / 4 μin		0.15 μm / 6 μin	0.03 μm / 1.2 μin	≤ 0.08 μm / 3.15 μin
Hysteresis f <sub>h</sub>	0.2 μm / 8 μin		0.2 μm / 8 μin	0.5 μm / 20 μin	0.08 μm / 3.15 μin
<b>Linearity deviation with corrected sensitivity</b>					
within range ± 0.3 mm	-		-	0.9 μm / 36 μin	-
within range ± 0.5 mm	0.5 μm / 20 μin		1.0 μm / 40 μin	-	-
within range ± 1.0 mm	2.0 μm / 80 μin		4.0 μm / 160 μin	-	0.15 μm / 6 μin
within range ± 2.0 mm	-		-	-	0.4 μm / 16 μin
Protect. class acc. to IEC 60529	IP64		IP62	IP50	IP64
Cable length			1.5 m <sup>2)</sup>		
Compatibility - Mahr			LVDT		only with Millimar 1240
<b>Order no.</b>	<b>5313010</b>	<b>5313030</b>	<b>5313049</b>	<b>5313180</b>	<b>5313400</b>

<sup>1)</sup> Relative to the electrical zero point

<sup>2)</sup> Extension cables are available, see accessories

Inductive Probe Millimar 1301 / 1303 / 1304 K / 1318 / 1340

M

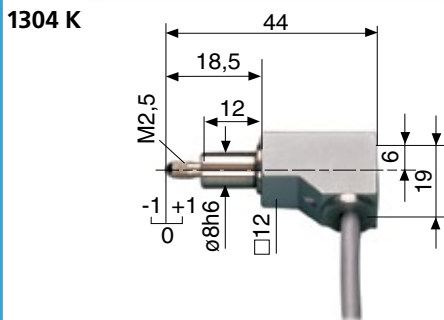
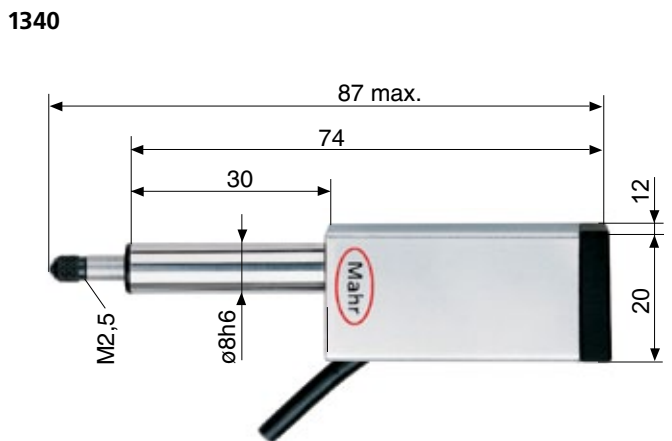
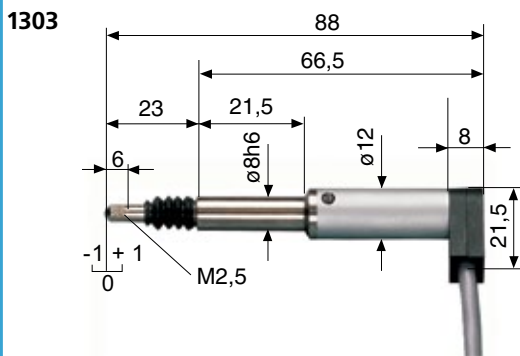
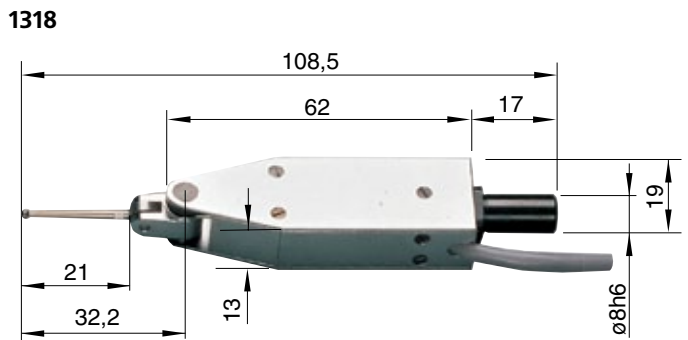
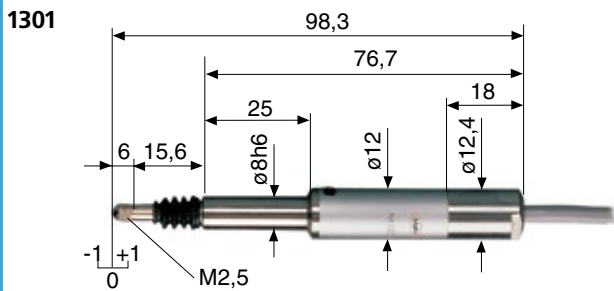

Accessories

	Description	Order no.
<b>Extension Cables</b> for 1301 / 1303 / 1304 K / 1318	<b>1288/1</b> 1 m / 3 ft	<b>5312881</b>
	<b>1288/2,5</b> 2.5 m / 8 ft	<b>5312882</b>
	<b>1288/5</b> 5 m / 16 ft	<b>5312885</b>
	<b>1288/7,5</b> 7.5 m / 24 ft	<b>5312887</b>
	<b>1288/10</b> 10 m / 30 ft	<b>5312889</b>
	<b>Cable Release</b> for 1301 / 1303	<b>1399</b>
<b>Styluses</b> for 1318 with carbide ball	d = 2 mm; L = 21 mm*	<b>3005223</b>
	d = 0.5 mm; L = 21 mm	<b>7003901</b>
	d = 1 mm; L = 21 mm	<b>7003902</b>
	d = 3 mm; L = 21 mm	<b>7003903</b>
<b>Styluses</b> for 1318 with ruby ball	d = 2 mm; L = 21 mm	<b>8004231</b>
	<b>Pneumatic Lifter</b> for 1340	<b>1340/1</b>
Pneumatic hand pump with an plug-in hose ca. 1 m / 3 ft	<b>1340/1F</b>	<b>5313419</b>
<b>Pneumatic Foot Switch</b> for 1340 for connecting up to 4 P1300 Probes		

\* Supplied with 1318



## Lever Type Gage Heads

F



EHE-2056

### Features

- Clutch-mounted contact swivels through 280° arc for easy positioning
- Linearity – 0.1% over full range of  $\pm 0.250$  mm /  $\pm 0.010$ "
- Gaging pressure less than 4 g / .14 oz. in either direction, with a change of less than 0.1 gram per 25  $\mu$ m / .001" of contact travel.
- Repeatability better than 0.1  $\mu$ m / 4  $\mu$ in
- Cable length – 1.2 m / 4 ft

For use on test stands, surface plate work, or where light pressure is needed.

### Automatic Cosine Error Compensation

Angle "A"	Correction Factor
10	.985
20	.940
30	.866
40	.766
50	.643
60	.500

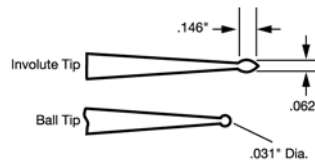

Involute tip (normally furnished) automatically corrects for cosine error when finger is at an angle up to 20°. Simplifies "reach over" jobs.

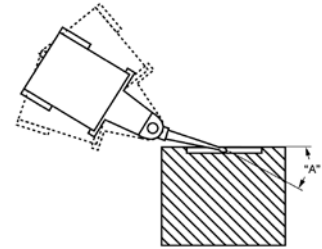

When exceeding 20°, use ball tip contact and table above. With multiplier function, 832F & 1840F Amplifiers can correct for cosine error.

### Accessories

**Adaptor** to mount EHE-2048 on Model 2400 Stand

**Clamp** for mounting EHE-2048 on model 2300 Stand

**Accessories kit** for EHE-2048. Includes EAM-1071, CP-116, EPT-1013, two rectangular holding bars and a holding rod

**Replacement tip**, 1.6 mm / .062" dia. steel ball

**Replacement tip**, 0.787 mm / .031" dia. tungsten carbide ball

**Replacement tip**, steel involute (normally furnished)

**Replacement tip**, 0.787 mm / .031" steel ball

**Replacement tip**, 1.6 mm / .062" dia., sapphire ball, 1:1 ratio

**Replacement tip**, 1.6 mm / .062" dia., sapphire ball, 2:1 ratio

**Replacement tip**, 1.6 mm / .062" dia., sapphire ball, 3:1 ratio

**Replacement tip**, 1.6 mm / .062" dia., sapphire ball, 4:1 ratio

**Replacement tip**, 1.6 mm / .062" dia., sapphire ball, 5:1 ratio

**Replacement adjustable nose mounting bracket**

**Replacement fixed back plate mounting bracket**

### Order no.

EAM-1071

CP-116

EAS-1333

EPT-1004

EPT-1007

EPT-1008

EPT-1013

EPT-1059-W1

EPT-1059-W2

EPT-1059-W3

EPT-1059-W4

EPT-1059-W5

EAT-1010

EPL-1140

## Lever Type Gage Heads

F

### Models and Accessories

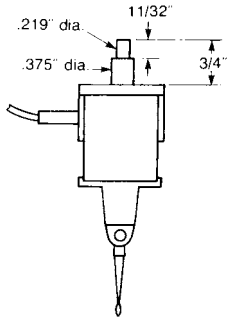

**Model EHE-2048** – Post Bracket Back, (BK-108) tamper-proof mounted. Option: Conversion Bracket, EAM-1071 (sold separately), attaches quickly and securely in any rotational direction to suit a wide variety of mounting needs.

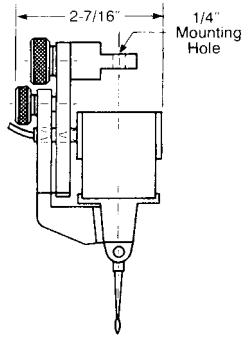

**Model EHE-2056** – Adjustable Nose Mount (EAT-1010), tamper-proof mounted. Permits wide choice of positions and approximately 3.8 mm / .150" fine adjustment for quick setup with support close to gaging contact.

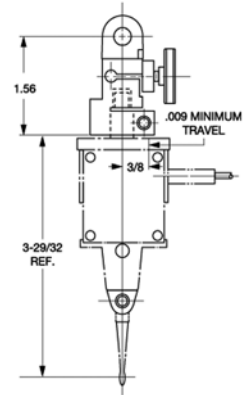

**Model EAT-1026** – Fine Adjust Attachment for Lever Type Gage Heads with post mounting option, permits mounting on a wide variety of fixtures.

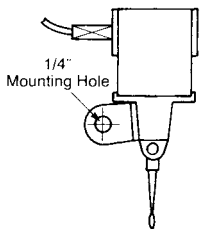

**Model EHE-2050** – Fixed Nose Mount (EAM-1045), tamper-proof mounted. Provides support close to gaging contact for the most critical applications.

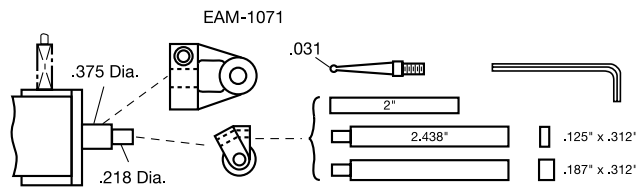

**Model EAS-1333** – Mounting Kit for use with EHE-2048. Permits Gage Head to be mounted on a wide variety of stands and holding fixtures. Includes Conversion Bracket, EAM-1071 and 0.787 mm / .031" diameter ball tip contact.

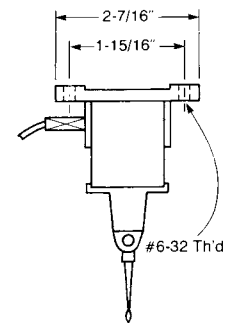

**Model EHE-2052** – Fixed Back Plate, (EPL-1140) tamper-proof mounted. For mounting on adjustable plates or slides in fixtures for continuous duty application.

## Spring (Pantograph) Type Gage Heads

F



### Features

- Friction-free, straight line motion.
- Repeatability better than  $0.01 \mu\text{m} / .5 \mu\text{in}$
- Linearity – 0.05% over full range of  $\pm 0.250 \text{ mm} / \pm 0.010''$ , with repeat accuracy within  $0.01 \mu\text{m} / .5 \mu\text{in}$ .
- Adjustable pretravel.
- Gaging pressure provided by external spring, from 85 g / 3oz. to 400 g / 14 oz.
- Uses regular 4-48 threaded Contact Points (PT-223 normally furnished).
- Cable length – 2.4 m / 8 ft.

Rugged and reliable, ideal for fixtures or automatic gages

### Technical Data

#### Model EHE-2053

Fixed Back Plate EPL-1140 (15.8 mm / 0.625" wide), tamper-proof mounted. Provides means of attachment for mounting on adjustable plates or slides in fixtures for continuous duty application.

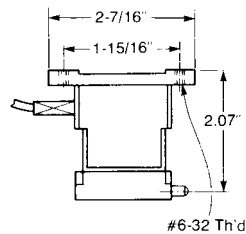

#### Model EHE-2049

Pressure Spring mount, tamper-proof mounted. Permits setting pre-travel and provides ample gaging pressure regardless of Gage Head position.

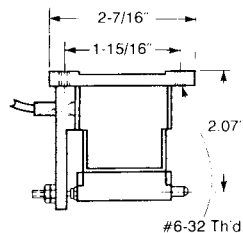

#### Model EGH-2011

Protective Housing encloses head in tamper-proof mounting. Permits adjustment of both gaging pressure (from 3 to 14 oz.) and pre-travel.

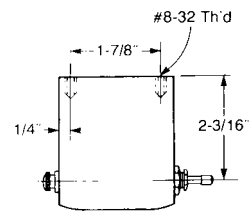

#### Model EGH-2006

Housing is extended and equipped with heavy duty back plate forming suitable support for use with Model 700 Comparator Stand.

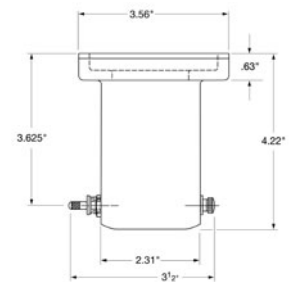

### Gage Head Adapter Cables

#### Order no.

**Gage Head Adapter Cables** connects Mahr Federal EHE-2XXX and P2XXXF gage heads to Mahr Federal series 432 and 230 amplifiers; 152 mm / 6" long

**ECB-1852**

**Gage Head Adapter Cables** connects Mahr Federal EHE 1XXX gage heads to Mahr Federal series 832 and 830 amplifiers; 152 mm / 6"

**ECB-1853**

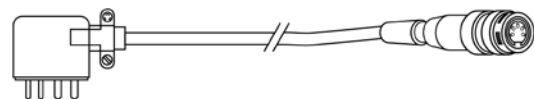

## Adapters for Cartridge Type Gauge Heads

F

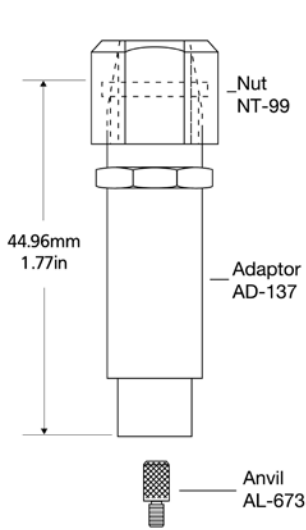

### AD-138

Electronic probe adapter permits using cartridge type gauge heads with any regular Mahr Federal indicator.

### AT-29

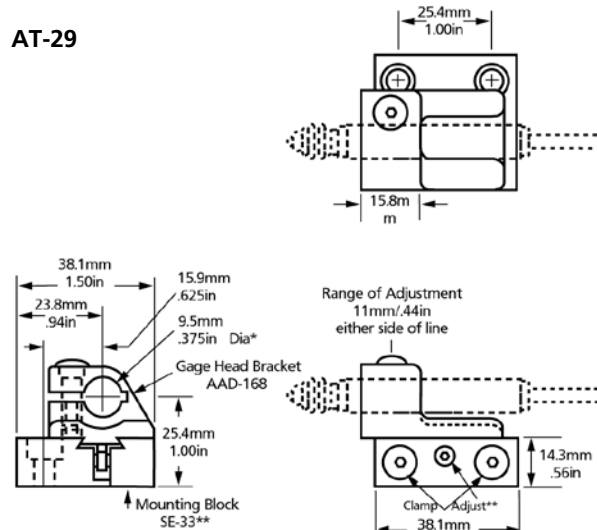

\* For .315"/8mm dia. gage heads, bushing BU-197 (not shown) is required.  
 \*\* Gage Head Bracket AAD-168 also fits SE-73 Mounting Block (with adjustment knob in place of socket head adjustment screw)

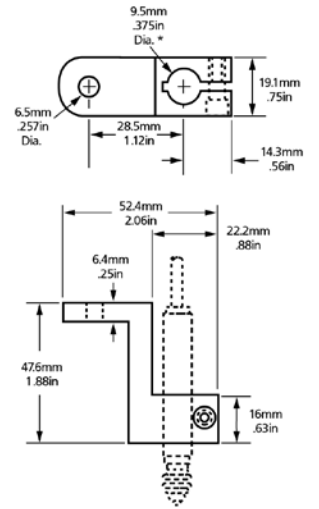

### AAD-66

"L" bracket used for mounting .375" diameter gage heads on comparator stands.

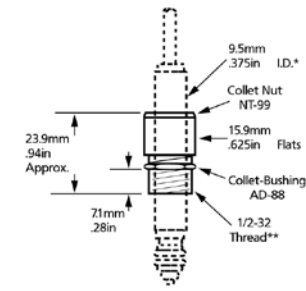

\* For .315"/8 mm dia. gage heads, bushing BU-197 (no shown) is required.

### AD-87

Split collar adapter for mounting .375" dia. gage heads. For 1/2-32 taps use **V-892**

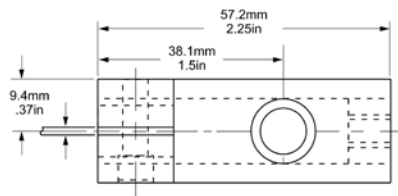

\* For .375"/8mm dia. gage heads, bushing BU-197 (not shown) is required.

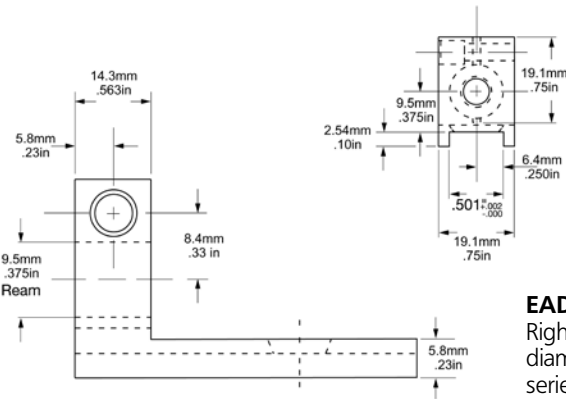

### EAD-1029

Right angle adapter for mounting .375" diameter cartridge gage heads on 36B series comparators.

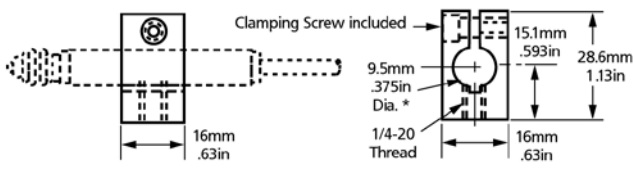

\* For .315"/8 mm dia. gage heads, bushing BU-197 (no shown) is required.

### AAD-67

For .375" diameter stem, square bracket. 1/4-20 mounting thread.

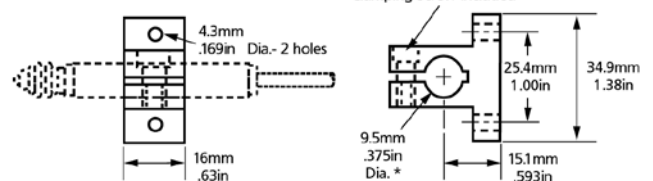









\* For .315"/8 mm dia. gage heads, bushing BU-197 (no shown) is required.

### AAD-91



"T" bracket flange mounted, two 4.3 mm / .169" through holes. For .375" dia. gage heads.

# Millimar. Evaluation Instruments

## OVERVIEW

	C 1200 IC	830	832	C 1208 / C 1216	C 1245
					
Catalog page	7 - 22	7 - 23	7 - 24	7 - 26	7 - 28
Display	Large analog scale with 2 tolerance markers	Needle analog scale	Analog display with 1 digital line display	Background lit LCD with an analog display and a two line digital display	Analog scale with a two line digital display
Measuring channels	1 Inductive Probe (A)	According to type, up to: <ul style="list-style-type: none"> <li>• 2 Inductive Probes (A, B)</li> </ul>	According to type, up to: <ul style="list-style-type: none"> <li>• 2 Inductive Probes (A, B)</li> <li>• 1 Pneumatic device (A, B)</li> </ul>	According to type, up to: <ul style="list-style-type: none"> <li>• 2 Inductive Probes (A, B)</li> <li>• 1 Pneumatic device</li> </ul>	According to type, up to: <ul style="list-style-type: none"> <li>• 8 Inductive Probes</li> <li>• 4 Incremental Probes</li> <li>• 2 Pneumatic devices</li> <li>• 8 Analog Signals</li> </ul> or a combination of the above
Compatible Inductive Probe (carrier frequency)	Mahr	Mahr Federal	Mahr / Mahr Federal	Mahr / Mahr Federal	Mahr / TESA / Mahr Federal
Max. Resolution	0.1 $\mu\text{m}$ / <b>.000005"</b>	0.1 $\mu\text{m}$ / <b>.000005"</b>	0.01 $\mu\text{m}$ / <b>.000001"</b>	0.1 $\mu\text{m}$ / 0.01 $\mu\text{m}$ * <b>.000005"/.000001" *</b>	0.1 $\mu\text{m}$ / <b>.000005"</b>
Input Combinations	+A, - A	+A, - A, +B, -B, A + B, A - B, B - A, -A - B	+A, - A, +B, -B, A + B, A - B, B - A, -A - B	+A, - A, +B, -B, A + B, A - B, B - A, -A - B	Formula editor for 80 characters Functions: + / - / * / +/- () / Factor
Features / Programs	1	2 / 2	2 / 2	2 / 2	16 / 6
Test steps	1	1	1	1	6
Dynamic measurements 	—	—	MAX, MIN, MAX-MIN, (MAX+MIN)/2	MAX, MIN, MAX-MIN, (MAX+MIN)/2, mean	MAX, MIN, MAX-MIN, (MAX+MIN)/2, mean
Statistics functions	—	—	—	—	N, x-bar, S, Xmax, Xmin, Range
Classification	—	—	5 class LED and I/O	3 class LED and I/O	max. 998, max. 62 on I/O
Control inputs and outputs / SPS connections 	—	—	3 inputs, 5 TTL Opto-coupler outputs	3 Opto-coupler inputs, 3 Opto-coupler outputs	3 Opto-coupler inputs, 6 Opto-coupler outputs
Analog output	—	1	1	1*	1
Data interfaces / ports 	—	—	RS232, 9 pin, plug	RS232, 9 pin, plug	RS232, 9 pin, plug
Configuration	Turn switch	Turn switch	Keypad	PC, Keypad	PC, Keypad
Battery operated	Yes	Yes	Yes or AC powered	No, AC powered	No, AC powered
Dimensions in mm (H x W x D)	137 x 157 x 80	165 x 190 x 148	254 x 168 x 143	205 x 160 x 165	210 x 160 x 155

\*Only C1216

1240	S 1840	X 1715	X 1741	1901 TA	G 1275 incl. D1200 X
					
7 - 29	7 - 30	7 - 31	7 - 32	7 - 33	7 - 34
Evaluation instrument with 2 adjustable tolerance markers	1 illuminated bar and a two line digital display	None Only via PC, supplied with Software D1000X	None Only via PC, supplied with Software D1000X	None Measuring amplifier with analog output	15"-TFT-Bildschirm 1024 x 768 Pixel Touchscreen
2 Inductive Probes (A, B)	According to type, up to: <ul style="list-style-type: none"> <li>• 2 Inductive Probes (A, B)</li> <li>• 1 Pneumatic device</li> </ul>	According to type, up to: <ul style="list-style-type: none"> <li>• 8 Inductive Probes</li> <li>• 4 Incremental Probes</li> <li>• 8 Analog Signals</li> <li>• 2 Temperature Sensors</li> </ul> or a combination of the above	According to type, up to: <ul style="list-style-type: none"> <li>• 16 Inductive Probes</li> <li>• 8 Incremental Probes</li> <li>• 8 Analog Signals</li> <li>• 4 Temperature Sensors</li> </ul> or a combination of the above	1 Inductive Probe	According to interface  4 - 128 for: Inductive Probes, Incremental Probes, Pneumatic Probes, Analog Signals
Mahr	Mahr / Mahr Federal	Mahr / TESA / Mahr Federal	Mahr / TESA / Mahr Federal	Mahr	Mahr / TESA / Mahr Federal
0.01 $\mu\text{m}$ / <b>.00001"</b>	0.1 $\mu\text{m}$ / 0.01 $\mu\text{m}$ <b>.000005"/.000001"</b>	0.1 $\mu\text{m}$ / <b>.000005"</b>	0.1 $\mu\text{m}$ / <b>.000005"</b>	—	0.1 $\mu\text{m}$ or 0.01 $\mu\text{m}$ <b>.000005"/.000001"</b>
+A, -A, +B, -B A+B, +A-B, -A+B, -A-B	A, -A, B, -B, A+B, A-B, -A+B, -A-B	Formula editor for 80 characters Functions: + / - / * / +/- ( ) / Factor	Formula editor for 80 characters Functions: + / - / * / +/- ( ) / Factor	—	Freely programmable
2 / 2 1	2 / 2 1	16 / 6 6	16 / 6 6	1 —	99 / 1000 99
MAX, MIN, MAX-MIN, (MAX+MIN)/2, mean n, xn, x, s, R	MAX, MIN, MAX-MIN, (MAX+MIN)/2, mean —	MAX, MIN, MAX-MIN, (MAX+MIN)/2, mean N, x-bar, S, Xmax, Xmin, Range	MAX, MIN, MAX-MIN, (MAX+MIN)/2, mean N, x-bar, S, Xmax, Xmin, Range	— —	MAX, MIN, MAX-MIN, Freely programmable Freely programmable
max. 30 digital, 3 class LED and I/O	5 class display, 3 class I/O	max. 998, max. 5 on I/O	max. 998, max. 79 on I/O	—	Yes
3 Opto-coupler inputs, 3 TTL outputs	3 Opto-coupler inputs, 3 Opto-coupler outputs	3 Opto-coupler inputs, 6 Opto-coupler outputs	6 Opto-coupler inputs, 12 Opto-coupler outputs	—	16 Digital inputs (Optional) 16 Digital outputs (Optional)
1	1	1	2	1 Output voltage 1 Current output	—
RS232, 9 pin, plug	RS232, 9 pin, plug	RS232, 9 pin, plug	RS232, 9 pin, plug	—	1 x RS232, 3 x USB, 2 x Ethernet (RJ45)
Keypad No, AC powered 195 x 156 x 120	PC, Keypad No, AC powered 487 x 47 x 144	PC No, AC powered 160 x 205 x 165	PC No, AC powered 235 x 180 x 160	— No, AC powered 170 x 43 x 100	PC, Touchscreen No, AC powered 305 x 400 x 65

**Millimar 1200 IC** Compact amplifier

**M**



**1200 IC**

**Features**

- Compact housing
- Battery powered for portable usage in the workshop
- Large analog display with 2 tolerance markers
- Quick and reliable display of the measured value
- Switchable measuring direction
- One inductive probe can be connected
- Fine adjustment due to the large range zero setter
- Battery operation with the commercially available round R14 batteries
- Test button for batteries
- Supplied with: Mains adapter and operating instructions

**Technical Data**

	<b>1200 IC</b>	<b>1200 IC/MZ</b>
Measuring range / Resolution	± 3 µm / 0.1 µm ± 10 µm / 0.2 µm ± 30 µm / 1 µm ± 100 µm / 2 µm ± 300 µm / 10 µm	± .0001" / .00002" ± .0003" / .00001" ± .001" / .00002" ± .003" / .0001" ± .01" / .0002"
Scale length		120 mm / <b>4.724"</b>
Response time		350 ms
Single meas. combinations		+A, -A
Range of zero adjustment: 5 and 100 µm		1 Large range setter
Deviation spread referring to measuring range		≤ 2.5%
Protection class acc. to DIN		IP40
Working temperature range		+ 10... + 40° C / + 50... + 104° F
Power supply		mains adapter, 9V = ~5 VA
Power consumption		ca. 0.1 W
Dimensions		137 x 157 x 80 mm / <b>5.394" x 6.181" x 3.149"</b>
Weight		1 kg / 2.205 lbs
<b>Order no.</b>	<b>5312000</b>	<b>5312009</b>

**Accessories**

**Order-no.**

**Battery**, R 14 battery 1.5 V, (6 are required) **3004424**

For appropriate Inductive probes please refer to pages 7-6 to 7-15

**Millitron 830** Gaging amplifier

**F**



**Features**

- Battery operates more than 8 hours under full load
- Choice of Power Modules for 120 or 240 VAC operation
- ±2 volt analog output
- Conforms to CE Standards
- Dual input - for single or differential modes
- Normal/Reverse transducer setting
- Selectable ranges in either Inch or Metric units.
- Calibration adjustments for each input.
- Convenient, front-mounted controls.
- Tilt base provides stable support and easy adjustment for best viewing angle.
- The essential performer for today's slim budgets
- For appropriate inductive probes please refer to pages 7-6 to 7-18

**Technical Data**

<b>Repeatability</b>	to within 0.00005 mm / <b>.000002"</b> or 1/10 of a graduation, whichever is greater
<b>Linearity</b>	less than 4/5 of a scale division
<b>Calibration</b>	less than 4/5 of a scale division
<b>Response Speed-Display</b>	less than .5 seconds for 10% to 90% step follow
<b>Response Time - Output</b>	< 15 ms
<b>Dimensions</b>	approx. 165 mm / 6.5" h x 190 mm / 7.5" w x 148 mm / 5.8" d
<b>Temperature at specified accuracy</b>	20°C / 68°F ±.2°C
<b>Operating temperature</b>	5° to 45°C / 40° to 110°F, with a temperature coefficient of .02% change/°C x full scale range
<b>Storage temperature</b>	0° to 60°C / 32° to 140°F

Model	Order-no.			Ranges	Resolution
	120V	220V EU	240V UK		
<b>Linear:</b>					
<b>Standard Unit</b>				±100 µm / <b>±.004"</b>	5 µm / 200 µ"
830 F	<b>2121421</b>	<b>2121431</b>	<b>2121441</b>	±20 µm / <b>±.001"</b>	1 µm / 50 µ"
830 M	<b>2121404</b>	<b>2121405</b>	<b>2121425</b>	±10 µm / <b>±.0002"</b>	0.5 µm / 10 µ"
<b>High Resolution – Inch</b>				±200 µm / <b>±.004"</b>	10 µm / 200 µ"
830 F	<b>2121424</b>	<b>2121434</b>	<b>2121444</b>	±50 µm / <b>±.001"</b>	2.5 µm / 50 µ"
				±10 µm / <b>±.0001"</b>	0.5 µm / 5 µ"
<b>Angular:</b>	<b>120V</b>	<b>220V EU</b>	<b>240V UK</b>		
<b>Angular unit - ARCSEC</b> (used with Mahr Federal Level Heads)				±1000 Sec / <b>±.010"</b>	50 Sec / 500 µ"
830 F	<b>2121422</b>	<b>2121432</b>	<b>2121442</b>	±200 Sec / <b>±.002"</b>	10 Sec / 100 µ"
				±20 Sec / <b>±.0004"</b>	1 Sec / 20 µ"

**Accessories**

	Order-no.	Compatible Probes	
		Used on 830 F	Used on 830 M
<b>Analog Output Connector</b>	<b>PRT-2380</b>	P2001 F	P2001 M
<b>120V Battery Charger</b>	<b>EBY-1016</b>	P2004 F	P2004 M
<b>220V Battery Charger (EU)</b>	<b>EBY-1019</b>	P2010 F	P2010 M
<b>240V Battery Charger (UK)</b>	<b>EBY-1020</b>	P2104 F	P2104 M
<b>Battery</b>	<b>EBY-1021</b>	EHE-2XXX	1301, 1303,
<b>Battery Eliminator Kit for 110V Models</b>	<b>EKT-1237-W1</b>	EGH-Levels	1304, 1318
<b>Battery Eliminator Kit for 220 Models</b>	<b>EKT-1237-W2</b>		



## Millitron 832 Digital Electronic Amplifier



### Features

- Dynamics – simultaneously computes the minimum, maximum, T.I.R., nominal and actual gage head signal for dynamic measurement capability.
- Multi-Range – three selectable ranges in inch or metric units.
- Message Center – display provides a simple “menu-driven” setup procedure in English, French or Spanish.
- RS-232 Output – for communicating with Data Collection Devices.
- Two Gage Head Input – Independent reading or for providing the capability of “summing” for diameter reading, matching clearances, runout and parallelism.
- Angular units – selectable arc seconds or millirads for angular measurement applications (see Electronic Levels).
- User selectable password for full lockout capability or individual key lockout in both setup and gaging modes.

### Technical Data

	Measuring Range	Digital Resolution	Analog Minimum Grad.
<b>Linear</b>	±2 mm / <b>±0.100"</b> ±.200 mm / <b>±010"</b> ±.020 mm / <b>±001"</b>	.001 mm / <b>.0001"</b> .0001 mm / <b>.00001"</b> .00002 mm / <b>.000001"</b>	0.1 mm / <b>.005"</b> 0.01 mm / <b>.0005"</b> 0.01 mm / <b>.00005"</b>
<b>Angular</b>	5 mrad / ±1000 arc sec. 1 mrad / ±200 arc sec.	.005 mrad / 1 arc sec. .0005 mrad / 0.1 arc sec.	.25 mrad / 50 arc sec. .05 mrad / 10 arc sec.
<b>Auto Range</b>	Automatically selects the smallest range for the best resolution, in both linear and angular units		
<b>Repeatability</b>	±1 digit		
<b>Calibration Accuracy</b>	±1 digit		
<b>Linear Error</b>	Less than .025% of full scale		
<b>Response Time</b>	42 msec.		
<b>Thermal Stability</b>	.01% /C x full scale		
<b>Temperature Range: At Specified Accuracy</b>	20°C / 68°F ±2°C		
<b>Operating Storage</b>	5° to 45°C / 40° to 110°F, with a temperature coefficient of .02% change/°C x full scale range. 0° to 60°C / 0° to 140°F		
<b>Digital I/O</b>	Five TTL opto-isolated outputs		
<b>Data Output</b>	RS-232, transmits Channels A, B, or both, units, and tolerances		
<b>Analog Output</b>	±5 VDC full scale for displayed value signal		
<b>Measuring Modes</b>	Actual, Minimum, Maximum, T.I.R., Nominal		
<b>Tolerance Indicators</b>	Five LEDs		
<b>Weight</b>	3.5 lbs. / 1.58 kg		
<b>Dimensions</b>	168 mm w x 254 mm d x 143 mm h / <b>6.63"</b> w x <b>10"</b> d x <b>5.63"</b> h		
<b>Gage Head Display</b>	A, B or both at any time		
<b>Auto Power Off</b>	User selectable, up to 99 minutes of non-use		
<b>Power Requirements</b>	Rechargeable battery, 10 hour operation under full load: or 120 VAC/240 VAC 50-60Hz with power module (furnished with Amplifier)		
<b>Replacement Battery</b>	<b>EBY-1015</b> Ni-Cad rechargeable, 4.8v, 2.5 amp hours		

## Technical Data

Power	832 F Mahr Federal probe type Order no.	832 M Mahr probe type Order no.
120VAC adapter	2004005	2004000
US battery/120VAC charger	2004007	2004002
EU/UK 220/240VAC adapter	2004006	2004001
EU battery/220VAC charger	2004008	2004003
UK battery/240VAC charger	2004009	2004004

## Accessories

	Order no.
<b>Storage Cover</b> (opaque) – protection for the 832 Amplifier when used in harsh environments	<b>ECV-1276</b>
<b>Oil/Splash Cover</b> (clear) – protection for the 832 Amplifier when used in harsh environments	<b>ECV-1285</b>
<b>Footswitch for HOLD/RESUME</b> , 3 m / 10 ft cable (15 pin)	<b>ECB-1857</b>
<b>Footswitch for DYNAMIC RESET</b> , or remote zeroing 3 m / 10 ft cable (15 pin)	<b>ECB-1858</b>
<b>Footswitch for SEND DATA</b> , 3 m / 10 ft cable (15 pin)	<b>ECB-1859</b>
<b>Footswitch for DYNAMIC RESET</b> , or Remote Zeroing, 1.5m / 5 ft cable (Phone Plug)	<b>300-50</b>
<b>Remote pushbutton for DYNAMIC RESET</b> , or remote zeroing 1.5 m / 5 ft cable (Phone Plug)	<b>ECB-1855</b>
<b>Remote pushbutton for SEND DATA</b> , 1.5 m / 5 ft cable (15 pin)	<b>ECB-1860</b>
<b>Remote pushbutton for HOLD/RESUME and SEND DATA</b> , 3 m / 10 ft cable (15 pin)	<b>ECB-1868</b>
<b>Relay Box</b> – Five relays each with Normally Open/Normally Closed contacts; Contact Rating – 30 Vdc/120 Vac, 3 amps Power Supply – 120 Vac Dimensions – 39 mm x 129 mm x 134.6 mm d/1.53" x 5.082 x 5.3" with ECB-1886W-2, 6.1 mm/24" interconnect cable for amplifier to relay box	<b>EKT-1236-W3</b>
<b>Mating connector</b> , Digital I/O connector (15 pin MALE)	<b>ECN-1695-W2</b>
<b>Mating connector</b> , Reset Data connector (3/32 microphone plug)	<b>ECN-1693</b>
<b>Mating connector</b> , RS-232 Digital Output connector (9 pin FEMALE)	<b>ECN-1695-W1</b>
<b>Mating connector</b> , Gage Head to amplifier connector (5 pin MALE)	<b>ECN-1690</b>
<b>Battery Charger Modules</b> (For 832 Units using 3 pin connector)	
<b>Plug-in</b> 120 VAC, 50-60Hz charger for use with 120 Vac battery operated units	<b>EBY-1028</b>
220 VAC, 50-60Hz charger for use with 220 Vac battery operated units	<b>EBY-1029</b>
240 VAC, 50-60Hz (UK) charger for use with 240 Vac battery operated units	<b>EBY-1030</b>
<b>Power Supply Module</b> (Bypass battery operated units to direct AC source operation)	
For 120 Vac models (For 832 Units using 3 pin connector)	<b>2010000</b>
For 220/240 Vac models (For 832 Units using 3 pin connector)	<b>2010001</b>
For appropriate inductive probes please refer to pages 7-6 to 7-18	

## Millimar C 1208 Compact amplifier with background lit display



### Features

- Favorites, frequently required functions can be assigned to the SELECT key
- Static measurements  $\pm A$ ,  $\pm B$  and all combinations
- Dynamic measurements: Max, Min, Max-Min, Max+Min, mean
- Auto-Detect-Mode, two measuring instruments can be connected (Probe, Plug Gage . . .)
- Programmable via the integrated key pad or by RS232 interface in conjunction with the MS-Windows configuration Software

### Display

- Background lit LCD-Display with an analog and a two line digital display
- 5 three color status lamps for warning and tolerances limits
- Up to 2 features can be simultaneously displayed

### Connections

- 2 inputs for inductive probes (also compatible with probes from Mahr, Mahr-Federal)
- RS232 interface
- 3 digital inputs for measurement start, master measurement, send measured values, . . .
- 3 digital outputs for GO, NO GO, rework, measuring time, . . .
- Supplied with:  
Operating instructions and a mains power supply plug

## Technical Data

Display	Background LCD, 115 mm x 70 mm
Analog scale	Pointer, 61 graduations
Range and text display	7 digit LCD, 5 x 7 dot matrix, alpha-numeric
Measured value display	7 digit LCD, 7 segments
Tolerance display	5 LEDs, 3 colors
Displayed ranges	$\pm 3, 10, 30, 100, 300, 1000, 3000, 10000 \mu\text{m}$ <b><math>\pm .0001; .0003; .001; .003;</math></b> <b><math>.01; .03; .1; .3 \text{ inch};</math></b> or tolerance related
Meas. range inductive probe	4000 ( $\pm 2000$ ) $\mu\text{m}$ , resolution 0.1 $\mu\text{m}$ <b><math>\pm .08''</math>, resolution <math>.000005''</math></b>
<b>Response time</b>	
- Meas. value memory	0.010s
- Digital display	0.100s
- Analog display	0.100s
- Outputs	0.020s

### Error limit

- 10 x analog display	2.5%
- Digital display	0.3% (min. 0.2 $\mu\text{m}$ )
Temperature coefficient	0.005%/ $^{\circ}\text{C}$
Operating temperature	0 $^{\circ}\text{C}$ . . . 45 $^{\circ}\text{C}$ / 32 $^{\circ}\text{F}$ . . . 113 $^{\circ}\text{F}$

### Interfaces

Computer, printer	RS232, 9 pin interface (PC-compatible assignment)
- Control outputs	3 Opto-coupler-outputs, 2 24V, 100mA
- Control inputs	3 Opto-coupler-inputs, 24V, 10mA
Power supply via Mains power pack	100V . . . 240V, 47Hz . . . 63Hz
Power consumption	10 VA
Protection class	IP54, with conductive dust IP43
Housing dimensions (H x W x D)	ca. 205 mm x 160 mm x 165 mm <b>ca. 8.07" x 6.29" x 6.49"</b>
Weight	ca. 2.1 kg / 4.6 lbs

## Order no.

		Order-no.
<b>C 1208 M</b>	Mahr compatible	<b>5312080</b>
<b>C 1208 F</b>	Mahr-Federal compatible	<b>5312082</b>

## Accessories

	Order-no.
<b>Extension cable</b> (9 pin D-Sub-jack to a D-Sub-socket), length 3 m / 10 ft	<b>7024634</b>
<b>Control Unit</b> with 3 push buttons	<b>5318430</b>
<b>Foot switch</b> for	
for Input 1	<b>5330955</b>
for Input 2	<b>5330956</b>
for Input 3	<b>5330957</b>
<b>Adapter</b> non wired for I/O port	<b>7032401</b>
<b>Keypad dust cover</b>	<b>3025712</b>

For appropriate Inductive probes please refer to pages 7-6 to 7-18

## Millimar C 1216 Compact amplifier with background lit display



### Features

- Favorites, frequently required functions can be assigned to the SELECT key
- Static measurements  $\pm A$ ,  $\pm B$  and all combinations
- Dynamic measurements: Max, Min, Max-Min, Max+Min, mean
- Auto-Detect-Mode, two measuring instruments can be connected (Probe, Plug Gage . . .)
- Programmable via the integrated key pad or by RS232 interface in conjunction with the MS-Windows configuration Software

### Display

- Background lit LCD-Display with an analog and a two line digital display
- 5 three color status lamps for warning and tolerances limits
- Up to 2 features can be simultaneously displayed
- Additional resolution 0.01  $\mu\text{m}$  / 1  $\mu\text{in}$  at measuring ranges  $\pm .008''$

### Connections

- 2 inputs for inductive probes (also compatible with probes from Mahr, Mahr-Federal)
- RS232 interface
- 3 digital inputs for measurement start, master measurement, send measured values, . . .
- 3 digital outputs for GO, NO GO, rework, measuring time, . . .
- Analog output
- Programable analog output voltage (max.  $\pm 5\text{V}$ )
- Supplied with: Operating instructions and a mains power supply plug

## Technical Data

Display	Background LCD, 115 mm x 70 mm
Analog scale	Pointer, 61 graduations
Range and text display	7 digit LCD, 5 x 7 dot matrix,
alpha-numeric	
Measured value display	7 digit LCD, 7 segments
Tolerance display	5 LEDs, 3 colors
Displayed ranges	$\pm 3, 10, 30, 100, 300, 1000, 3000, 10000 \mu\text{m}$ <b><math>\pm .0001; .0003; .001; .003; .01; .03; .1; .3 \text{ inch};</math></b> or tolerance related
Meas. range inductive probe	4000 ( $\pm 2000$ ) $\mu\text{m}$ , resolution 0.1 $\mu\text{m}$ <b><math>\pm .08''</math>, resolution <math>.000005''</math></b> 400 ( $\pm 200$ ) $\mu\text{m}$ , resolution 0.01 $\mu\text{m}$ <b><math>\pm .008''</math>, resolution <math>.000001''</math></b>
<b>Response time</b>	
- Meas. value memory	0.010s
- Digital display	0.100s
- Analog display	0.100s
- Outputs	0.020s

### Error limit

- 10 x analog display	2.5%
- Digital display	0.3% (min. 0.2 $\mu\text{m}$ )
Temperature coefficient	0.005%/ $^{\circ}\text{C}$
Operating temperature	0 $^{\circ}\text{C}$ . . . 45 $^{\circ}\text{C}$ / 32 $^{\circ}\text{F}$ . . . 113 $^{\circ}\text{F}$

### Interfaces

Computer, printer	RS232, 9 pin interface (PC-compatible assignment)
- Control outputs	3 Opto-coupler-outputs, 2 24V, 100mA
- Control inputs	3 Opto-coupler-inputs, 24V, 10mA
Power supply via Mains power pack	100V . . . 240V, 47Hz . . . 63Hz
Power consumption	10 VA
Protection class	IP54, with conductive dust IP43
Housing dimensions (H x W x D)	ca. 205 mm x 160 mm x 165 mm <b>ca. 8.07" x 6.29" x 6.49"</b>
Weight	ca. 2.1 kg / 4.6 lbs

## Order no.

	Order-no.
<b>C 1216 M</b> Mahr compatible	<b>5312160</b>
<b>C 1216 F</b> Mahr-Federal compatible	<b>5312162</b>

For appropriate Inductive probes please refer to pages 7-6 to 7-18

## Accessories

	Order-no.
<b>Extension cable</b> (9 pin D-Sub-jack to a D-Sub-socket), length 3 m / 10 ft	<b>7024634</b>
<b>Control Unit</b> with 3 push buttons	<b>5318430</b>
<b>Foot switch</b> for	
for Input 1	<b>5330955</b>
for Input 2	<b>5330956</b>
for Input 3	<b>5330957</b>
<b>Adapter</b> non wired for I/O port	<b>7032401</b>
<b>Keypad dust cover</b>	<b>3025712</b>

## Millimar C 1245 Compact amplifier



### Features

#### Functions

- 16 characteristics can be defined
- With the formula editor (80 characters) the input channels C1 to C8 are mathematically linked with 4 basic arithmetical functions with factors and brackets
- Static measurements: current value, square root, arc tangent
- Dynamic measurements: Max, Min, Max-Min, Max+Min, mean,
- Statistical functions: n, x-bar, S, Xmax, Xmin, R
- Programmable via the integrated keypad or with MS-Windows configuration software via the RS232 interface
- Memory can store up to 500 measurements
- Measurement Start / Stop

#### Display

- Analog indicator instrument for display of measurement values

- Two-line LCD for measuring values and help texts
- 5 three color status lamps for warning and tolerance limits
- Up to 3 features can be simultaneously displayed

#### Connections

- 2 input modules can be inserted into base unit
- Following modules are available:
  - 4 inputs for Inductive Probes (Mahr, Mahr-Federal, Tesa compatibility)
- RS232 interface
- 1 Analog output
- 3 digital inputs for measurement start, master measurement / zeroize, send data
- 6 digital outputs for GO, NO GO, rework, ALL GO, measuring time, 4 classes
- Supplied with:
  - Operating instructions and a mains power supply plug

### Technical Data

Display	analog indicator instrument. LCD 53 mm x 40 mm (2.087" x 1.585")	<b>Error limits</b>	- 10 x Analog display 2 % - Digital display 0.3 % (min. 0.2 μm) Temperature coefficient ± 0.005%/°C Oper. temperature range 0°... 50°C
Analog scale	145 mm x 80 mm (5.709" x 3.149")	<b>Interfaces</b>	Computer, printer RS232, 9 pin interface (PC-compatible layout)
Range and Text display	7-point LCD, 5 x 7 dot matrix. alphanumeric	- Control outputs	6 Optocoupler-outputs, 24V, 100mA
Measured value display	7-point LCD. 7 Segment	- Control inputs	3 Optocoupler-inputs, 24V, 10mA
Tolerance display	5 LEDs, 3-colors	Analog output. voltage	programmable
Display ranges	± 10, 30, 100, 300, 1000, 3000, 10000 μm ± .0003; .001; .003; .01; .03; .1; .3 inch	Power supply	90 V... 264 V, 47Hz... 63Hz
Measuring range inductive probe	4000 (±2000) μm, resolution 0.1 μm (measured value display ± .08", resolution .000005"	Power consumption	11 VA
<b>Response time</b>		Protection class	IP53 with conductive dust IP43
- Meas. value memory	0.005s	Housing dimensions (H x B x T)	ca. 210 mm x 160 mm x 155 mm <b>ca. 8.268" x 6.299" x 6.103"</b>
- Digital display	0.300s	Weight	ca. 2 kg / 4.40 lbs
- Analog display	0.050s - 0.300s		
- Outputs	0.020s		

### Order no.

	Order no.
<b>C 1245 M</b> Mahr compatible for 4 inductive probes	<b>5331250</b>
<b>C 1245 M</b> Mahr compatible for 8 inductive probes	<b>5331291</b>
<b>C 1245 F</b> Mahr-Federal compatible for 4 inductive probes	<b>5331253</b>

For appropriate Inductive probes please refer to pages 7-6 to 7-18

### Accessories

	Order-no.
<b>Extension cable</b> (9 pin D-Sub-jack to a D-Sub-socket), length 3 m / 10 ft	<b>7024634</b>
<b>Control Unit</b> with 3 push buttons	<b>5318430</b>
<b>Foot switch</b> for Millimar for Input 1	<b>5330955</b>
for Input 2	<b>5330956</b>
for Input 3	<b>5330957</b>
<b>Adapter</b> non wired for I/O port	<b>7032401</b>
<b>Keypad dust cover</b>	<b>3025712</b>

**Millimar 1240** Compact amplifier

**M**



**Features**

- Highly accurate processing of measured values
- Zero setting is possible at any point within the measuring range
- Actual value of a standard can be acquired at the touch of a button
- Statistical functions x-bar, s, r and n for 1 parameter
- Tolerance monitoring (with adjustable hysteresis)
- Tolerance field can be set along the total width
- Universal classification possibilities
- Extreme value memories of long stability
- 2 inputs for Mahr compatible inductive probes for single, sum or difference measurements
- Use the RS232C interface to connect a printer / computer / data logger
- Connect a recorder with analog output
- Use the RS232C interface to remotely control all functions
- Supplied with: Operating instructions and a mains power supply plug

**Technical Data**

Display	analog/digital
<b>Analog display:</b> Measuring range/resolution	
	± 1 µm/0.02 µm ( <b>±.003"/.0001"</b> )
	± 3 µm/0.1 µm ( <b>±.01"/.0002"</b> )
	± 10 µm/0.2 µm ( <b>±.03"/.01"</b> )
	± 30 µm/1 µm ( <b>±.1"/.002"</b> )
	± 100 µm/2 µm ( <b>±.3"/.01"</b> )
	± 300 µm/10 µm ( <b>±.00003"/.000001"</b> )
	± 1000 µm/20 µm ( <b>±.0001"/.000002"</b> )
	± 3000 µm/100 µm ( <b>±.0003"/.00001"</b> )
	± 10000 µm/200 µm ( <b>±.001"/.00002"</b> )
<b>Digital display:</b> Measuring range/resolution	
	± 200 µm/0.01 µm ( <b>±.08"/.000001"</b> )
	± 2000 µm/0.1 µm ( <b>±.008"/.000001"</b> )
Single meas/ combinations	+A, -A, +B, -B, A+B, +A-B, -A+B, -A-B
Dynamic Functions (Max+Min)/2, mean	Max, Min, Max-Min,
Static Functions	n, xn, x, s, R
Zero adjuster	Zero setting at any point

**Deviation spread referring to measuring range**

Analog display	≤ 1.5 %
Digital display	≤ 0.01%
Analog output	≤ 1 %
Output voltage	± 5 V
Data output	RS 232 C
Limit switches	2
Signal lamps	3
Response time	15 ms
Control outputs	3
Type of output	TTL
Control inputs	3
Protection class acc. to DIN	IP40
Working temperature range	+10 ... +40°C / + 50. ... + 104° F
Power supply	230 V~/115 V~ ± 10%, 50-60 Hz (switchable)
Power consumption	ca. 30 VA
Dimensions (W x H x D)	156 x 195 x 120 mm <b>6.142" x 7.677" x 4.724</b>
Weight	2.3 kg / 5.07 lbs

**Order no.**

Version	Order no.
<b>1240</b> Front Panel English	<b>5312401</b>

For appropriate Inductive probes please refer to pages 7-6 to 7-15  
Recommended **Probe 1340** see page 7-14

**Accessories**

	Order no.
<b>Push buttons 1240/3D</b> for activating 3 different functions e.g., Start, zero setting etc., connection cable 1.5 m/ 5ft	<b>5312430</b>
<b>Foot Switch 1240/1F</b> , connection cable length 2 m/ 5ft	<b>5312431</b>
<b>Control Unit 1240/SG</b> with 3 push buttons and 5 relay outputs	<b>5312439</b>
<b>Data Cable</b> to any. PC (9 pin D-jack)	<b>7024634</b>

## Millimar S 1840 Compact column amplifier

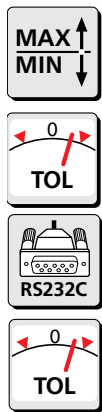

### Features

- Easy to read 3 color analog display
- Measurement in conjunction with inductive probes (e.g. Mahr P2004) or electronic plug gages etc
- Two inputs for inductive probes (compatible with probes from Mahr, Mahr-Federal)
- Extensive calculation of input signals:  $\pm A$ ,  $\pm B$  and all combinations
- Dynamic measurements: Max, Min, Max-Min, Max+Min, Mean
- Programmable either via the integrated keypad or the RS232 interface by means of MS-Windows configuration software
- Programmable warning and tolerance limits, exceeding the limit causes the color to change from green to yellow to red
- Background lit 2 lined LCD to display measured values, help text and measuring units
- Analog output
- 3 digital inputs (e.g. start of measurement, master measurement)
- 3 digital outputs for GO – NO GO – rework, measuring time
- Programmable analog output voltage  $\pm 5$  V
- Supplied with: Operating instructions and a mains power supply plug

### Technical Data

Analog display	101 LED elements, 3 colors
Range and Text display	7 point LCD, 14 Segment, alphanumeric
Measured value display	7 point LCD, 7 Segments
Tolerance display	via color changes in the analog display
Display ranges	$\pm 10; 30; 100; 300; 1000; 3000; 10000 \mu\text{m}$ <b><math>\pm .0003; .001; .003; .01; .03; .1; .3 \text{ inch}</math></b> or tolerance related
Meas. range inductive probe	4000 ( $\pm 2000$ ) $\mu\text{m}$ , resolution 0.1 $\mu\text{m}$ <b><math>\pm .08''</math>, resolution <b><math>.000005''</math></b> 400 (<math>\pm 200</math>) <math>\mu\text{m}</math>, resolution 0.01 <math>\mu\text{m}</math> <b><math>\pm .008''</math>, resolution <b><math>.000001''</math></b></b></b>
<b>Response time</b>	
- Meas. value memory	0.008 s
- Analog display	0.020 s
- Outputs	0.020 s

<b>Error limits</b>	
- 10 x Analog display	1% (101 LEDs)
- Digital display	0.3% (min. 0.2 $\mu\text{m}$ )
Temperature coefficient	$\pm 0.005\% / ^\circ\text{C}$
Operating temp. range	0 ... 45 $^\circ\text{C}$ / 32 $^\circ\text{F}$ ... 113 $^\circ\text{F}$

<b>Interfaces</b>	
Computer, printer	RS232, 9 pin. male (PC-compatible layout)
- Control outputs	3 Optocoupler Outputs, 24 V, 100 mA
- Control inputs	3 Optocoupler Inputs, 24 V, 10 mA
Analog output	Voltage $\pm 5$ V programmable
Power supply	90 ... 264 V, 47 ... 63 Hz
Power consumption	12 VA
Protection class	IP53
	IP43 with conductive dust
Dimensions (H x W x D)	ca. 487 x 47 x 144 mm <b>ca. 19.173" x 1.850" x 5.669"</b>
Weight	ca. 1.6 kg / 3.53 lbs

### Order no.

	Order no.
<b>S 1840 M</b> Mahr compatible	<b>5318400</b>
<b>S 1840 F</b> Mahr-Federal compatible	<b>5318402</b>

For appropriate Inductive probes please refer to pages 7-6 to 7-18

### Accessories

	Order no.
<b>Base Plate</b> , for up to 3 columns	<b>5330901</b>
<b>Wall Mounting</b>	<b>5330902</b>
<b>Connection Cable</b> (9 pin D-Sub-jack to D-Sub-jack), length 3 m / 10 ft	<b>7024634</b>
<b>Control Unit</b> with 3 push buttons	<b>5318430</b>
<b>Foot Switch</b> for Millimar	Input 1 <b>5330955</b>
	Input 2 <b>5330956</b>
	Input 3 <b>5330957</b>
<b>Adapter</b> non wired for I/O port	<b>7032401</b>

## Millimar X 1715 Intelligent measurement interface system



### Features

**Millimar X 1715** is a smart and universal measurement interface system for complex measuring tasks on the production floor. It is ideal as a signal transformer between sensors and the electronic measured data processing.

#### Functions

- Static and dynamic measurements
- Equation editor
- Definition of 16 features are possible
- One or two point master measurement

#### Connections

- 1 to 8 measuring device inputs
- RS-232 interface
- Analog output
- 3 digital inputs and 6 digital outputs
- Supplied with: Operating instructions, connection cable and a mains power supply plug

### Technical Data

Measuring range inductive probe 4000 ( $\pm 2000$ )  $\mu\text{m}$ ,  $\pm .08''$   
Resolution 0.1  $\mu\text{m}$ ,  $.000005''$

#### Response time

- Meas. value memory 0.005s
- Outputs 0.020s

#### Error limits

- 0.3% (min. 0.2  $\mu\text{m}$ )

Temperature coefficient  $\pm 0.005\%/^{\circ}\text{C}$   
Oper. temperature range  $0^{\circ}\dots 50^{\circ}\text{C}$  /  $32^{\circ}\text{F}\dots 122^{\circ}\text{F}$

#### Interfaces

- Computer, printer RS232, 9 pin interface (PC-compatible layout)
- Control outputs 6 Optocoupler-outputs, 24V, 100mA
- Control inputs 3 Optocoupler-inputs, 24V, 10mA

Analog output voltage	programmable
Power supply	90 V ... 264 V, 47Hz ... 63Hz
Power consumption	11 VA
Protection class	IP53 IP43 with conductive dust
Dimensions (H x B x T)	ca. 160 x 205 x 165 mm <b>ca. 6.30" x 8.07" x 6.49"</b>
Weight	ca. 2 kg / 4.40 lbs

### Order no.

		Order no.
<b>X 1715</b>	Mahr compatible for 2 Inductive probes	<b>5331064</b>
<b>X 1715</b>	Mahr compatible for 4 Inductive probes	<b>5331063</b>
<b>X 1715</b>	Mahr compatible for 8 Inductive probes	<b>5331061</b>

For appropriate Inductive probes please refer to pages 7-6 to 7-14

### Accessories

	Order no.
<b>Connection Cable</b> (9 pin D-Sub-jack to D-Sub-jack), length 3 m / 10 ft	<b>7024634*</b>
<b>Control Unit</b> with 3 push buttons	<b>5318430</b>
<b>Foot Switch</b> for Millimar	<b>5330955</b>
Input 1	<b>5330956</b>
Input 2	<b>5330957</b>
Input 3	<b>7032401</b>
<b>Adapter</b> non wired for I/O port	<b>7032401</b>

\* Included in the scope of supply



## Millimar X 1741 Intelligent measurement interface system



### Features

**Millimar X 1741** is a smart and universal measurement interface system for complex measuring tasks on the production floor. It is ideal as a signal transformer between sensors and the electronic measured data processing.

#### Functions

- Static and dynamic measurements
- Equation editor
- Definition of 16 features are possible
- One or two point master measurement

#### Connections

- 1 to 16 measuring device inputs
- RS-232 interface
- 2 analog outputs
- 6 digital inputs and 12 digital outputs
- Supplied with: Operating instructions, connection cable and a mains power supply plug

### Technical Data

Measuring range inductive probe 4000 ( $\pm 2000$ )  $\mu\text{m}$ ,  $\pm .08''$   
Resolution 0.1  $\mu\text{m}$ ,  $.000005''$

#### Response time

- Meas. value memory 0.005s
- Outputs 0.020s

#### Error limits

- 0.3% (min. 0.2  $\mu\text{m}$ )

Temperature coefficient  $\pm 0.005\%/^{\circ}\text{C}$   
Oper. temperature range  $0^{\circ} \dots 50^{\circ}\text{C} / 32^{\circ} \text{F} \dots 122^{\circ} \text{F}$

#### Interfaces

- Computer, printer RS232, 9 pin interface (PC-compatible layout)
- Control outputs 12 Optocoupler-outputs, 24V, 100mA
- Control inputs 6 Optocoupler-inputs, 24V, 10mA

Analog output voltage	programmable (2 outputs)
Power supply	90 V ... 264 V, 47Hz ... 63Hz
Power consumption	11 VA
Protection class	IP53 IP43 with conductive dust
Dimensions (H x W x D)	ca. 235 mm x 180 mm x 160 mm <b>(9.25" x 7.08" x 6.29")</b>
Weight	ca. 2 kg / 4.40 lbs

### Order no.

		Order no.
<b>X 1741</b>	Mahr compatible for 4 Inductive probes	<b>9037840</b>
<b>X 1741</b>	Mahr compatible for 8 Inductive probes	<b>9038383</b>
<b>X 1741</b>	Mahr compatible for 12 Inductive probes	<b>5331057</b>
<b>X 1741</b>	Mahr compatible for 16 Inductive probes	<b>5331096</b>

For appropriate Inductive probes please refer to pages 7-6 to 7-14

### Accessories

	Order no.
<b>Connection Cable</b> (9 pin D-Sub-jack to D-Sub-jack), length 3 m / 10 ft	<b>7024634*</b>
<b>Control Unit</b> with 3 push buttons	<b>5318430</b>
<b>Foot Switch</b> for Millimar	Input 1 <b>5330955</b>
	Input 2 <b>5330956</b>
	Input 3 <b>5330957</b>
<b>Adapter</b> non wired for I/O port	<b>7032401</b>

\* Included in the scope of supply

## Millimar Measuring Amplifier 1901 TA with analog output

**M**



### Features

- The measuring amplifier 1901 TA is to be used in connection with an inductive probe for measurement control processes
- Provides the inductive probe with an AC voltage and converts the carrier frequency signal into output voltage
- Output voltage:  $\pm 10$  V (Option:  $\pm 5$  V / 0 V to 10 V) at the end of the measuring range
- Simultaneously the output signal current of  $\pm 5$  mA at the end of the measuring range is available
- Supply voltage 24 V=
- The housing of the 1901 TA is designed for use in the machine room
- Connections : 1 output for one Mahr compatible inductive probe
- Supplied with: 3 pin socket plug for analog output, 3 pin coupling bushing for power supply and operating instructions

### Technical Data

<b>Measuring ranges</b> (adjustable through bridges)	$\pm 125 \mu\text{m}$ ( <b><math>\pm .00492''</math></b> )	<b>Connections</b>	Input	5 pin socket
	$\pm 250 \mu\text{m}$ ( <b><math>\pm .00984''</math></b> )		Output	3 pin socket
	$\pm 500 \mu\text{m}$ ( <b><math>\pm .01968''</math></b> )		Supply	3 pin plug
	$\pm 1000 \mu\text{m}$ ( <b><math>\pm .03937''</math></b> )		Response time	5-10 ms
	$\pm 2000 \mu\text{m}$ ( <b><math>\pm .07874''</math></b> )		Cut-off frequency	90 Hz
Output voltage at end of measuring range	$\pm 10$ V	Protection class	IP 54	
Option:	$\pm 5$ V / 0-5 V / 0-10 V	Dimensions: (L x D x H)	<b>43 x 100 x 170 mm</b> <b>(1.69" x 3.93" x 6.69")</b>	
Current output at end of measuring range	$\pm 5$ mA			
Linearity	$\pm 0.3\%$			
Supply voltage	24 V =			

### Order no.

#### Order no.

<b>1901 TA</b>	Mahr compatible for 1 Inductive probe	<b>5319011</b>
<b>1901 TA/So</b>	Mahr compatible for 1 Inductive probe 0- 10 V	<b>9023856</b>

For appropriate Inductive probes please refer to pages 7-6 to 7-14

## Millimar G1275

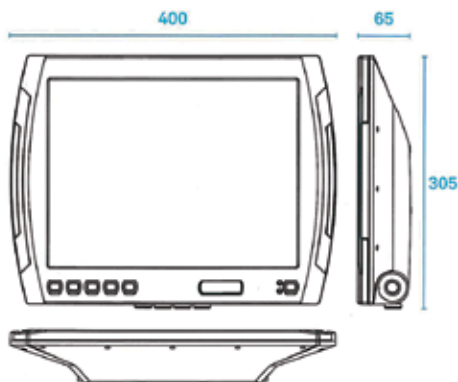
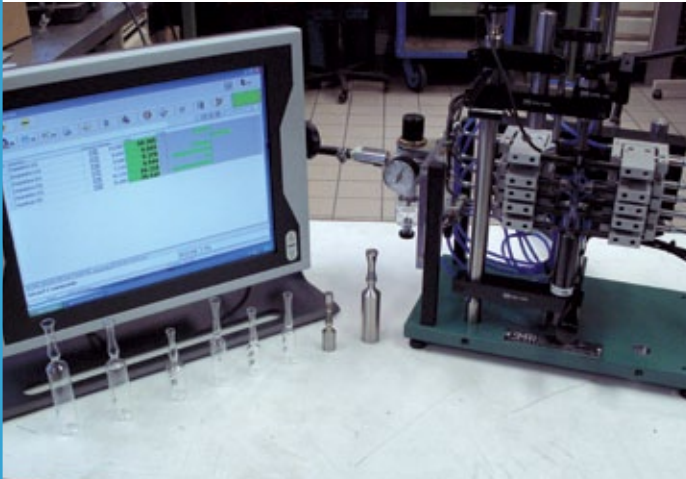

VMT 6015

### Description

With the measuring computer **Millimar G1275**, measuring results from multi-gaging units can easily be recorded and statistically evaluated.

The industrial housing makes the measuring computer suitable for use in the rough production area.

The compact dimensions of the housing allow for use of the computer in areas with little space.

The measuring results are clearly shown on the 15" TFT monitor, which avoids reading errors and misinterpretations.

Using the touchscreen, the measuring computer can be reliably operated in the production environment.

To record the measuring signals from the most different sensors, a broad spectrum of measuring interfaces can be connected to the measuring computer Millimar G1275.

### Technical Data

Dimensions (LxDxH)	305 x 400 x 65 mm
Weight	4,3 kg
Material	Aluminum pressure die-cast powder-coated
Operating temperature	0 °C . . . 55 °C
Relative humidity	10 % to 85 % non-condensing
Protection class	IP65
TFT color monitor	15" 1024 x 768 pixel
Touch	Resistive industry touchscreen
Power supply	230 V ± 10 % AC / 24V DC (via external mains unit)

### Interfaces

<b>Inputs/Outputs</b>	1 RS232 (COM1) 1 input for keyboard/mouse 2 Ethernet connection (RJ45) 2 USB on the back side 1 USB in the front panel
-----------------------	--

## Software Millimar D1200X

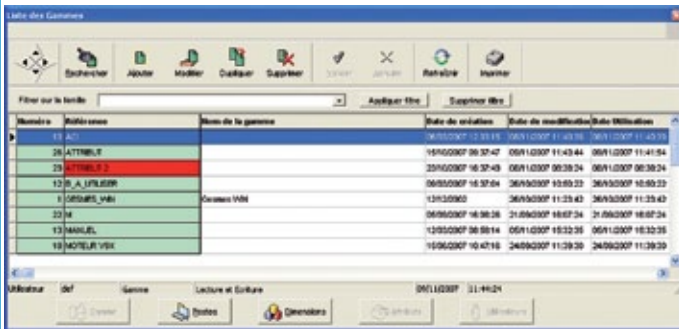

### Description

- Windows-based software
- ACCESS data bank
- Password protected menus and access authorization
- Free form editor
- Easy programming of the inspection plan by filling out masks
- Freely programmable calculation format
- Fast selection to display the measurements conducted
- Aid monitor for easy adjustment of sensors
- Calibration history is saved
- Measuring value display (numerical and as a bar graph)
- Measurement is saved (manually or automatically)
- Monitoring of the working range of the sensors and alarm
- Statistical evaluation of a measuring result
- Depiction as a histogram and SPC control card.
- Automatic calibration demand after hours and n measurements
- Inaccurate measuring values can be commented on with the reasons
- Statistical analysis
- Test of normal distribution
- Measurement systems analysis (R&R) and gage capability integrated
- Module to export in numerous data formats
- Interfaces to e.g. QDAS, SUMEQ, SESAME, QUASAR
- I/O interface for automatic control (option)
- Operation in automatic production lines with dialog control

### Minimum Requirements

- Pentium IV or similar processor with at least 1.5 GHz
- Windows 2000 or Windows XP
- 20 GB free memory on the hard drive
- 512 MB RAM
- Monitor 1024 x 768
- Free USB interface
- CD drive
- 1 to 4 RS232 interfaces, depending upon the number of peripheral units

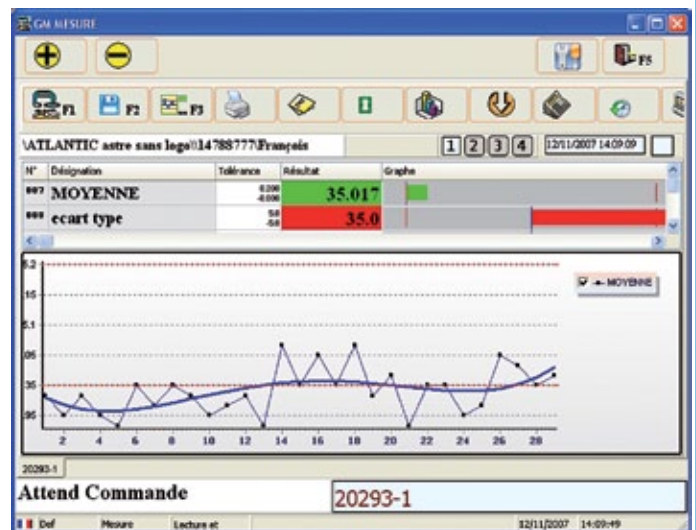
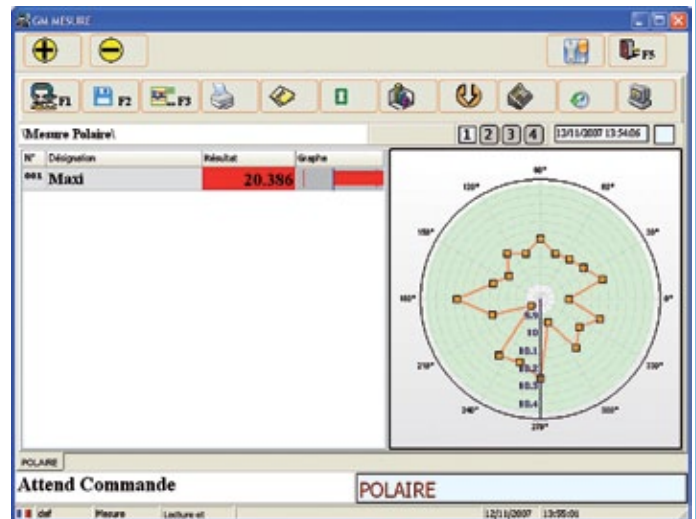
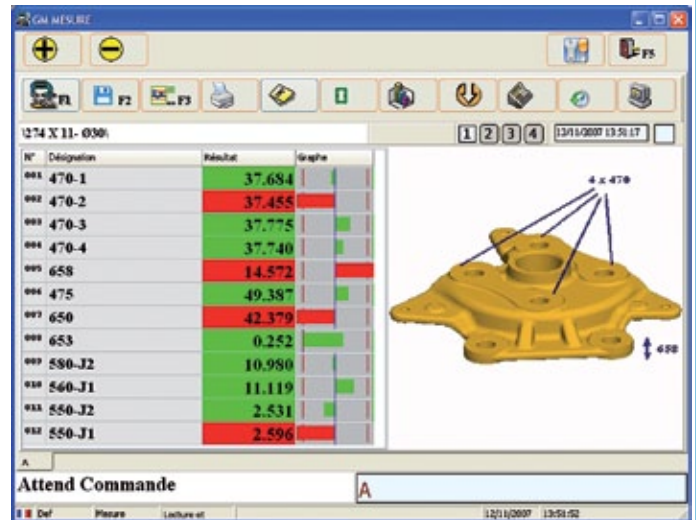

# Millimar. Electronic Levels

## OVERVIEW

### Electronic Levels Applications

F

Measuring with a Mahr Federal Electronic Level is a relatively simple procedure. In a typical profile application, for example, measurements are made by moving the sensing heads in convenient increments along a straight path on the surface being checked. Comparative readings are taken at each increment.

Computer assisted models allow economical, fast, and error-free calculations to be made automatically. As prompted by the computer, the operator simply enters the value at each measurement point by pressing a hand-held switch. Depressing a computer key activates automatic analysis. Within moments, the results are displayed and printed, if desired, for permanent record.

### Surface Deviation (Machine Tools)

The accuracy of machine tools begins with proper levelness plus the relationship between the ways and the table. These relationships are critical during the manufacturing process.

Once the level is zeroed, the instrument functions as a spirit level, and will check the overall levelness of the machine components to a very high degree of accuracy.

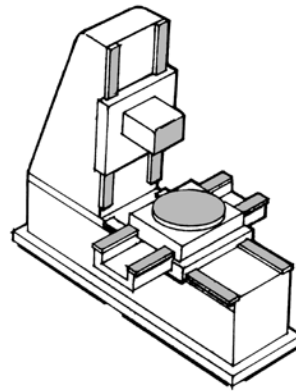

Shown here are just a few of the many surfaces that can be checked on a machine tool using the Electronic Level.

### Differential Sensing

To aid in differential profiling applications, two level sensing heads, operating simultaneously with a single amplifier, are used. When the sensing heads are arranged for opposite response to a common motion (such as vibration or a shift in attitude of the object whose surfaces are being compared), they will ignore the common motion and respond only to changes which affect the

two heads differentially. A deviation of flatness, squareness, parallelism or alignment, therefore, can be accurately determined even though the object (such as a surface plate or a machine way) does not maintain constant orientation.

### Surface Plate Flatness

The next progression in data collection is to combine and print a number of surface straightness checks onto a single chart. This is useful for checking the surface flatness of machine beds and surface plates.

Although the Moody Method for checking surface plates has been traditionally used to check flatness, the computer assisted digital Electronic Level System is ideally suited for highly precise profiling of surface plates and large machined surfaces while eliminating tedious and time-consuming data recording and calculations required by manual systems.

Determining surface flatness is accomplished by using a straight edge as a guide and moving the level along the edge.

Readings are recorded at convenient locations, and entered into the computer via handswitch to produce the surface profile.

### Machine Tool Evaluation

ANSI Standard B5.54, for machining center evaluation, refers to levels as an important part of machine evaluation, calling out angular deviation as a major contributor to machine tool errors.

Electronic Levels are ideal for monitoring such deviations as pitch, yaw and roll.

When used with the Spindle Mount Attachment (EAT-1062), levels become an essential tool towards total Machine Tool Evaluation.

## Electronic Levels

F

**Offer fast response, fine resolution and excellent repeatability**

### Features

- Used to determine any deviation in the right angle relationship between a horizontal surface and the earth's gravitational force (usually expressed as an angular or linear deviation from absolute level).
- Show any change in this relationship over time.
- Compare the orientation attitude of separate or adjacent horizontal surfaces.
- Show any change in this comparison over time.
- Level systems are angular-linear compatible.
- Sensing heads are interchangeable with Mahr Federal's gage heads to accommodate linear measurements.
- Fast Response: quick response to slight angular changes permit taking fast and accurate measurements at various sensing head positions or taking dynamic position readings.
- Resolution/Repeatability: Mahr Federal's Electronic Levels far exceed the sensitivity and accuracy of precision spirit levels with a resolution to 6 µin per foot (.1 arc second), compared to the spirit level's resolution of .0001" per foot. With repeatability at ±.1 arc second, Electronic Levels are ideal for ultra-high resolution profiling.
- Direct Dimensional Readout: multiplier feature permits operator to view displacement caused by the angular measurement of the level head; this is displayed as an inches per foot readout rather than arc seconds: eliminates readout confusion when switching from spirit levels to electronic levels.
- Angular-Linear Compatible: sensing heads are easily interchangeable with Federal gage heads to accommodate linear measurements.
- Operator Friendly: Level systems are often compared to the autocollimator or laser calibration systems. In each case, the measurement technique is basically the same. Electronic Levels, however, are much easier to set up and operate. Results are obtained cost-effectively without requiring time consuming sight path alignments. There are no optical surfaces to keep clean, and the Level does not need a turbulence-free environment to achieve accurate readings.



### How they work

As shown in the figure, our Sensing Head operates on the pendulum principle, with a pendulum supported by two reed springs attached to an extension block at the top of the Sensing Head housing.

Tilting the head causes a change in the position of the pendulum's shading loop in relation to the center leg of the core. This produces an electrical imbalance in the amount of flux passing through the two secondary coils, delivering a signal proportional to the displacement of the pendulum.

This is displayed on a Mahr Federal amplifier meter which is graduated in seconds of arc.

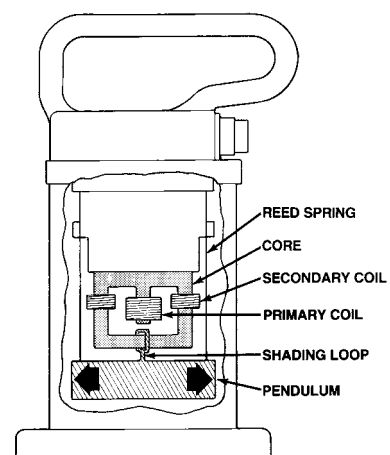

## Electronic Levels Ordering Information



### Differential Level System

The Differential Level System operates simultaneously with a single amplifier, permitting an immediate comparison between two surfaces.

Adjustable bases permit setup on surfaces that are out-of-level or square by as much as  $\pm 1.5^\circ$ .

Each system includes:

- 832 F Amplifier with power module and storage case
- 2 EGH-2013-W2 Electronic Level Heads with 6m / 20ft cables
- 2 EAT-1029 Adjustable Bases
- ECB-1871 Remote data enter handswitch with 6m / 20ft cable

### Ordering no.

#### Type

**Differential Level System** described above with 120 VAC 50/60 Hz power module  
**Differential Level System** described above with 220 VAC 50/60 Hz power module (EU)

#### Order no.

**EMD-832P-48-W1**  
**EMD-832P-48-W2**

### Automatic Profiling System

Ideally suited for highly precise profiles of surface plate and large machine surfaces, eliminating tedious and time-consuming data recording and calculating required by manual systems.

Each system includes:

- 832 F Amplifier with power module and storage case
- 2 EGH-2013-W2 Electronic Level Heads with 6m/20ft cables
- 2 EAT-1029 Adjustable Bases
- ECB-1871 Remote data enter handswitch with 6m/20ft cable
- 7024634 RS-232 0.6 m/4 ft interconnect cable, 9 pin-9 pin
- Notebook computer (EAS-2836) with notebook printer (ERO-1063) and cable (ECB-1775)
- Mahr Federal Profiling Software (EDD-1035) for single line profile measurements and Moody Method surface plate profiling. Includes 3 data outputs (printout of data point readings, numeric and isometric plots of surface plate readings)
- Serial - USB Adaptor



### Surface Plate Certification Software

- Moody and Profile Analysis
- Isometric or numeric plots
- Automatic grading according to industry standards
- On-line help
- Flexible path sequence and orientation
- Multiple run averaging
- Difference of Data Files

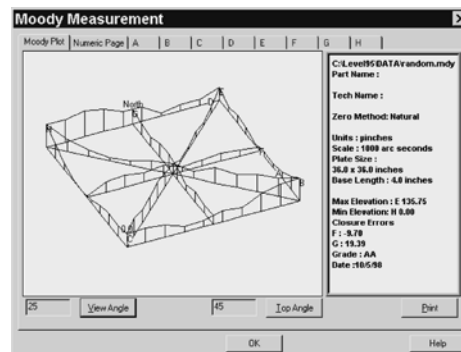

### Ordering no.

#### Type

**Automatic Profiling System** described above with 120 VAC 50/60 Hz power module  
**Automatic Profiling System** described above with 220 VAC 50/60 Hz power module (EU)  
**Surface Plate Certification Software**

#### Order no.

**EMD-832P-50-W1**  
**EMD-832P-50-W2**  
**EDD-1035**

## Electronic Levels Ordering Information

### Accessories

Type	Order no.
<b>Electronic Level Gage Head</b> , with 2.5m / 8 ft cable, 210 mm / 8.2" x 114 mm / 4.5" x 50.8 mm / 2" 3.5 kg / 7.75 lbs.	<b>EGH-2013-W1</b>
<b>Electronic Level Gage Head</b> , same as above except with 6 m / 20 ft cable	<b>EGH-2013-W2</b>
<b>Adapter Cable</b> , to connect EGH-13 Electronic Level Gage Heads or EHE-1xxx Gage Heads to a Series 832 & 830 Gaging Amplifier, 1.8 m / 6 ft long	<b>ECB-1853</b>



**EAT-1029 (Adjustable Leveling Foot)**

The adjustable level foot mounts to the base of the level head. Typically used to assist in leveling the head to its true zero position.



**EAT-1054 (Magnetic Base)**

Incorporates a magnet to fix it in position, providing stability when mounted on a moving carriage.



**EAT-1055 (Vee Base)**

Has a 120° Vee precision ground into the 102 mm / 4" base for measuring the straightness or alignment of cylindrical surfaces.

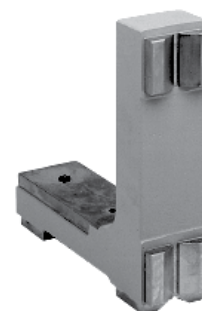

**EAT-1056 (Right Angle Attachment)**

Has two 152 mm / 6" surfaces, accurately ground to 90°, to simplify measuring flatness on horizontal or vertical and cylindrical surfaces. Each adjacent pair of faces is square to within 0.5 μm / 25 μin. Attachment includes 120° Vee face, which is parallel to its base to the same limit.



**EAT-1057 (Adjustable Base)**

A three-pad base lets you adjust the distance between the pads from 50 mm / 2" to 203 mm / 8" when using the "Grid" or "Union Jack" measuring methods. Can also be used for straightness movement checks.



**EAT-1062 (Spindle Block)**

A special spindle mounting block to hold the level head in a horizontal or vertical spindle. Utilizes a 19 mm / .750" bar for mounting and allowing checking angular motion on a machine tool per B5.54 Calibration Standard.

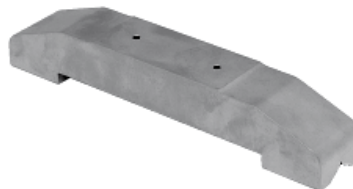

**EAT-1061 (29.5mm/11.625in Base)**

Has a 29.5 mm / 11.625" ground, flat surface for leveling machine beds and ways. It also has a 120° Vee ground into the base, permitting the base to be positioned on a cylindrical surface. When coupled with an 832 or 830 Electronic Amplifier while in the inch mode, it can display inches/feet as a direct reading.

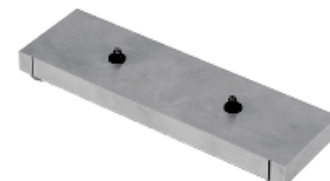

**EAT-1058 (50 mm / 2")  
EAT-1059 (102 mm / 4")  
EAT-1060 (152 mm / 6")**

A three-pad base which provides the flexibility to maximize data accumulation for surface plate calibration. Available in three pad spacing sizes.



## Millimar. Air Gage Metrology

### PRECISION BEGINS AT THE START OF THE MEASURING PROCESS

▶ | High pressure air gages measure dimension deviations quickly and precisely. For years, they have proven themselves as high quality pneumatic length measuring units in industrial production and measuring rooms. Air measuring value recorders such as jet air probes, jet air plug gages, jet air ring gages, air caliper gages, angularity plug gages, angularity measuring rings and measuring units for mating parts determine the measuring value without contact. The measuring values of one or several air measuring value recorders are displayed by the Millimar evaluation units according to the principle of determination of changes in air pressure. | ◀



## Millimar. Air Gage Metrology

### Metrological features

**Millimar** evaluation units work according to the principle of determination of changes in air pressure; the pressure differential between two chambers is measured. While one of the two chambers provides a constant reference pressure, the pressure of the other chamber (measuring chamber) is determined by the distance of the measuring jet of an air measuring value recorder to the test specimen.

Millimar evaluation units have two connection points that are each directly connected to one of the two pressure chambers. Thus the measuring value is measured directly without any conversion via a Piezo pressure sensor and is then digitalized.

Magnifications from 2500:1 to 10000:1 are realized with exchangeable instrument jets.

**Millimar** measuring units must be supplied with constant air pressure through a pressure reducing valve. Measuring units with pressure reducing valves can be connected to all compressed air lines from 3.5 bar to 10 bar overpressure, whereby an air filter should be interconnected.

**The air must be dry and oil-free.**



### Metrological features

- Universal, reliable, proven, especially high-performing
- All measuring methods, individual, total and differential measurements
- High accuracy, long-term stability, insensitive to environmental influences
- Up to 10000x magnification of the measuring values, large measuring ranges
- High measuring accuracy and reproducibility for the measuring results: depending upon the magnification 0.5  $\mu\text{m}$  to 20  $\mu\text{m}$
- Contact-free measurements with measuring jets, no damage to the workpieces
- Reliable measurements of even uncleaned, oiled, lubricated workpieces, or workpieces with lapping paste. Measuring points are cleaned by the measuring air
- Linear display of the measuring values on a clear, large or long scale, easy and error-free reading of measuring results
- Measurement of diameters, distance between holes, tapers, eccentricities, alignment of bores, mating measurements etc.
- Various measuring possibilities due to the corresponding adaption to existing measuring problems
- Airgage display unit for all applications
- Requires little room, handy, easy to use, all measuring methods
- Fully automatically working electrical units for measuring, control and sorting processes
- Measurement control unit for production machines
- **Millimar** single and multi-column units to set-up complete testing control units
- Multi-column units according to the modular construction system due to close arrangement of the measuring columns and long scales
- Versatile measuring elements: jet air probes, jet air plugs gage, jet air ring gages, air caliper gages, angularity plug gages, angularity measuring rings, taper jet plug gages, taper jet ring gages and measuring units for mating parts for contact-free measurement
- Unusually long life-time of the air measuring elements
- Robust model for the shop floor. Models for all applications.
- Special models for special tasks

### General Technical Data of Air Gages

Air gaging is a measuring system that uses air pressure to determine the size of measured part. The relationship between air pressure and distance of a restriction (workpiece) to the air escape (jets) can be plotted on a graph (line a).

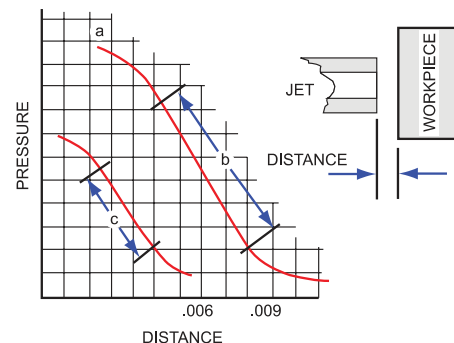

As the distance between jets and work surface increases, the pressure decreases and the ratio becomes linear as represented by the straight section "B". This straight portion of the curve can be accurately calibrated, and represents the scale of the Dimensionair. Compare its length with "C" on the other curve, which is the usable portion of other air gage scales. This longer linear scale gives the Dimensionair its longer usable measuring range.



# Millimar. Air Evaluation Units

## OVERVIEW

	Analog DA	Universal DA	µDimensionAir	832 DDA	C1208 PE
					
Catalog page	7 - 45	7 - 46	7 - 47	7 - 49	7 - 51
Display	Large analog scale with 2 tolerance markers	Large analog scale with 2 tolerance markers	Analog display with 1 digital line display	LCD with an analog display	Analog scale with a two line backlighted digital display
Measuring channels	Single channel	Single Channel	Single Channel	Single or Dual Channel	Single Channel
Compatible air tooling	Mahr Federal	Mahr Federal Universal	Mahr Federal Universal	Mahr Federal	Mahr Federal Universal
Max. Resolution	0.1 µm / <b>.000005"</b>	0.1 µm / <b>.000005"</b>	0.01 µm / <b>.00002"</b>	0.1 µm / 0.01 µm* <b>.000005"/.00001"</b>	0.1 µm / <b>.000005"</b>
Input Combinations				+A, -A, +B, -B, A + B, A - B, A + B, -A - B	Formula editor for 80 characters Functions: + / - / * / +/- ( ) / Factor
Features / Programs	1	1	1	1	16 / 6
Test steps	1	1	1	1	6
Dynamic measurements	—	—	MAX, MIN, MAX-MIN	MAX, MIN, MAX-MIN, (MAX+MIN)/2, mean	MAX, MIN, MAX-MIN, (MAX+MIN)/2, mean
Mastering Mode:	Nominal Master	Max/Min Master/ Nominal	Nominal or Max/Min	Nominal or Max/Min	Nominal or Max/Min
Classification	—	—	3 class	5 class LED and I/O	max. 998, max. 62 on I/O, 5 LED
Control inputs and outputs / SPS connections	—	—	—	5 Opto-coupler outputs	3 Opto-coupler inputs, 6 Opto-coupler outputs
Analog output	—	—	—	1	1
Data interfaces / ports	—	—	USB, ASCII/Digimatic	RS232, 9 pin, plug	RS232, 9 pin, plug
Configuration	Turn switch	Turn switch	Keypad	Keypad	Keypad
Battery operated	—	—	Yes	No, AC powered	No, AC powered
Dimensions in mm (H x W x D)	137 x 157 x 80	165 x 190 x 148	254 x 168 x 143	205 x 160 x 165	210 x 160 x 155

C 1245	1840PE
	
7 - 52	7 - 53
Analog scale with a two line digital display	Column analog scale, 2 line digital display
Single/Dual	Single
Mahr Federal Universal	Mahr Federal Universal
0.1 μm / <b>.000005"</b>	0.1 μm / <b>.000005"</b>
Formula editor for 80 characters Functions: + / - / * / +/- ( ) / Factor	+A, - A, +B, -B, A + B, A - B, B - A, -A - B
16 / 6	2 / 2
6	1
MAX, MIN, MAX-MIN, (MAX+MIN)/2, mean	MAX, MIN, MAX-MIN, (MAX+MIN)/2, mean
Nominal or Max/Min	Nominal or Max/Min
max. 998, max. 62 on I/O	Nominal or Max/Min
3 Opto-coupler inputs, 6 Opto-coupler outputs	3 Opto-coupler inputs, 6 Opto-coupler outputs
1	1
RS232, 9 pin, plug	RS232, 9 pin, plug
Keypad	Keypad
No, AC powered	No, AC powered
137 x 157 x 80	165 x 190 x 148

**Other display options available upon request**

**832 Differential**



832 performs match gage operation

**1841**



1841 configured for multiple diameters:

- Taper angle
- Taper difference

**Mar-Chek**



Gaging computer for signal combination, statistics, operator sequence, etc.

# Millimar. Air Evaluation Units

## MEASURING COMPLEX TASKS TO THE POINT

▶ | Evaluation instruments have many different applications and therefore need to meet a broad range of requirements. They can perform anything from simple measurements on the shop floor to complex applications with a whole host of test features in fully automated production lines. These applications require high levels of reliability and precision combined with straightforward operation. Millimar evaluation instruments meet these requirements perfectly. Robust, compact, bright light-strip instruments, measurement interfaces for a wide range of applications and easy-to-use measuring computers can all be adapted for different probes and tailored to suit your particular application. | ◀

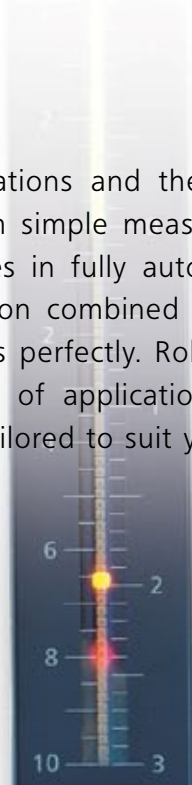

**Dimensionair® Air Gages** (single master system)

F



**Features**

- Uses regular shop air (40 - 150 psig).
- Internal pressure regulator keeps measuring pressures within calibrated range.
- Adjust meter to zero using a single setting master and the zero setting screw.
- High visibility meter has fine line graduations and a needle-thin hand for clear, precise readings. An air filter is included to remove dust and dirt contaminants from air line.
- Tooling mounts to the front of the unit. Connections are tight with finger pressure.
- No recalibration necessary when changing tooling. Just set zero and measure!
- Models available in 5 magnifications, 2 dial styles, and either Metric or Inch.

**Technical Data**

Magnification	Tooling ID no.	Range	Minimum Graduation	Dial Style	Surface Finish (recommended)		Maximum Part Tolerance (recommended)	Order no.
					µin Ra	µm Ra		
1250:1	100	.006"	.0001"	Regular 82.6 mm / 3.25" diameter	100	2.54	± .002"	2095183
2500:1	50	.003"	.00005"		50	1.27	± .001"	2095184*
5000:1	20	.0015"	.00002"		20	0.50	± .0005"	2095185*
10000:1	10	.0006"	.00001"		10	0.25	± .0002"	2095186
20000:1	5	.0003"	.000005"		5	0.12	± .0001"	2095189
1250:1M	100	152 µm	2 µm		100	2.54	± 50 µm	2095190
2500:1M	50	76 µm	1 µm		50	1.27	± 25 µm	2095191*
5000:1M	20	38 µm	0.5 µm		20	0.50	± 13.5 µm	2095192*
10000:1M	10	15.2 µm	0.2 µm		10	0.25	± 5 µm	2095193
20000:1M	5	7.6 µm	0.1 µm		5	0.12	± 2.5 µm	2095194
4000:1	50	.003"	.000025"	Large 152.4 mm / 6" diameter	50	1.27	± .001"	2095195*
8000:1	20	.0015"	.000010"		20	0.50	± .0005"	2095196*
16000:1	10	.0006"	.000010"		10	0.25	± .0002"	2095197
32000:1	5	.0003"	.000005"		5	0.12	± .0001"	2095198
4000:1M	50	76 µm	0.5 µm		50	1.27	± 25 µm	2095199*
8000:1M	20	38 µm	0.2 µm	20	0.50	± 13.5 µm	2095200*	
16000:1M	10	15.2 µm	0.2 µm	10	0.25	± 5 µm	2095201	
32000:1M	5	7.6 µm	0.1 µm	5	0.12	± 2.5 µm	2095202	

\* Contingent upon Plug having equivalent range, see chart on pages 7-57, 7-58 and 7-59

## Dimensionair® Air Gages (single or dual master system)

F



Interchangeable Dials

Each Universal Dimensionair is furnished with an adaptor (for connecting standard Mahr Federal air tooling) Optional adaptors are available for virtually any air tooling application.

### Features

- Uses regular shop air (40 -150 psig).
- Internal pressure regulators and differential meter assure ultimate stability over full operating range.
- Adjust span and zero setting to tune the gaging range to the interchangeable dial ranges.
- Interchangeable dials provide an easy, inexpensive means to accommodate various ranges
- High visibility meter has fine line graduations and a needle thin hand for clear, precise readings.
- An air filter is included to remove dust and dirt contaminants from airline.
- Tooling mounts to the front of the unit. Adaptors are available for virtually any tooling configuration.

### Technical Data

Dial Size diameter mm / <b>inch</b>	82.6 / <b>3.25"</b>
Housing Dimensions mm	127 x 187 x 197 (high)
<b>inch</b>	<b>5" x 7.125" x 7.75"</b>
Weight (including filter) approx.	6.7 kg / 14.25 lbs.
Operating Pressure	414-1034 kPa / 60-150 psig

A plastic protective cover for Universal Dimensionair is available  
**Order no. ACV-1**

### Ordering Information

Universal Dimensionair, complete with air filter and standard tooling adaptor for Mahr Federal air tooling. Supplied with one **2242662** Dial. **Order no. 2098125**

#### Optional Dials

	Total Range	Range	Dial Graduations	Magnification	Order no.
(inch)	.006"	± .003"	.0001"	1260:1	<b>2242760</b>
	.004"	± .002"	.0001"	1875:1	<b>2242761</b>
	.003"	± .0015"	.00005"	2500:1	<b>2242662</b>
	.002"	± .001"	.00005"	3750:1	<b>2242763</b>
	.0015"	± .00076"	.00002"	5000:1	<b>2242764</b>
	.001"	± .0005"	.00002"	7500:1	<b>2242765</b>
	.0006"	± .0003	.00001"	10000:1	<b>2242766*</b>
(metric)	152 µm	± 76 µm	2 µm	1260:1	<b>2242770</b>
	100 µm	± 50 µm	2 µm	1875:1	<b>2242771</b>
	76 µm	± 38 µm	1 µm	2500:1	<b>2242772</b>
	50 µm	± 25 µm	1 µm	3750:1	<b>2242773</b>
	38 µm	± 19 µm	0.5 µm	5000:1	<b>2242774</b>
	15.2 µm	± 7.6 µm	0.2 µm	10000:1	<b>2242776*</b>

#### Tooling Adaptors

Adaptors are available for many standard-tooling configurations:

Thread/Adaptor style	Plug Type / Measured size	Order no.
10-32	2.7686 mm / <b>.109"</b> to 12.547 mm / <b>.494"</b>	<b>AAD-194** AAD-313</b>
1/4-28	12.547 mm / <b>.494"</b> to 23.876 mm / <b>.940"</b>	<b>AAD-193** AAD-312</b>
1/2-20	23.876 mm / <b>.940"</b> to 139.7 mm / <b>5.500"</b>	<b>AAD-195** AAD-314</b>
1/8 Barb	3/8-32 Female	<b>2242767</b>
Setlock	Moore	<b>2242777</b>
8mm	Mahr Row	<b>2240621</b>
12mm	Mahr Row	<b>2240623</b>
9/32-40	Mahr Federal High Mag	<b>AAD-165</b>

\* Requires AAD-165 adaptor, \*\* Includes bleed to simulate MFI jetting.



**μDimensionair® II Air Gages** (single or dual master system)

F

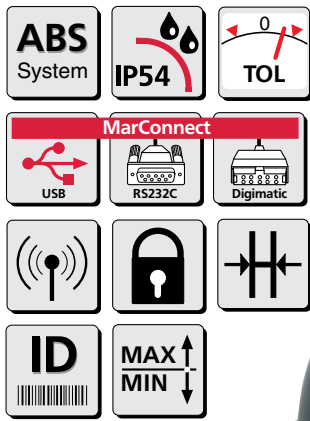

*The μDimensionair is the ultimate of portability and versatility – in your hand or at the workbench or machine tool. Shown with optional 2239307 Bench Kit*



All parts of the μDimensionair are completely interchangeable and included with the gaging system – versatility is built-in.

All μDimensionair gages are supplied with output capability.

**Features**

- **Affordable**
  - **Versatile**
  - **Innovative**
  - **Rugged**
- No other air gaging system offers so much – in the palm of your hand – mounted to the workbench or even right to the machine tool. μDimensionair is rated IP54, so, it can be used on the shop floor – and, the air tooling cleans dirt from the part for high performance measurements – fast and easy!
- Air gage readout is right in front of you – simple and clear.
- Fixed resolution and balanced air system makes the gage stable and reliable for your manufacturing environment.

**μDimensionair II offers:**

- Single and Min/Max mastering selectable
- All other features of the μMaxμm II Digital Indicator:
  - Dynamic Mode operation: Min, Max, TIR
  - Multiplier factor and hold function
  - Data output with selectable serial number
  - MarConnect data output: USB, OPTO RS232C, Digimatic

**Versatility**

The ultimate in configuration – interchangeable handle allows for pistol grip or normal end-mount for easy application of the plug to the part. For large, heavy plugs, mount the handle between the tooling and the display – assures a well-balanced, ergonomic measuring system. Can also be mounted to a bench stand when parts are brought to the gage.

**Accessories**



Bench stand provides safe and secure μDimensionair storage between measurements.

**Order no. 2241109**



Slide valve controls air to tooling – saves cost of wasted air, reduces air noise.

**Order no. 2240993**



Swivel coupling allows for rotating tooling to fully explore bore.

**Order no. 2240594**

*For applications where the local elevation is greater than 305m / 1000 feet, special calibration is required.*



**μDimensionair® II Air Gages** (single or dual master system)

F

**Technical Data**

		 <p><b>Resolution</b> 0.002mm, 0.001mm <b>.0001", .00005"</b> 0.001mm, 0.0005mm <b>.00005", .00002"</b> 0.001mm, 0.0005mm <b>.00005", .00002"</b></p> <p>USB / ASCII / Digimatic 6,000 hours</p> <p>5 - 35° C / <b>41 - 95° F</b> 0 - 60° C / <b>32 - 140° F</b> ± 1 Last Significant Digit (LSD) ± 1 Last Significant Digit (LSD) ± 1% full scale (LSD) Approximately 1 second 0.1% of full scale/F Two — over / under (3 Class) 25 kg / <b>5.5 lbs</b> approx. 100 x 60 x 70 mm / <b>approx. (4" x 2.5" x 3")</b> 15 minutes of non-use 3 volt lithium battery coin cell, 2 per unit — CR-2450 2.10 ± .01 bar / 30.4 ± .15 psi Rotates through 270 degrees</p> <p><b>2103200*</b></p>	<p><b>Tooling I.D. Numbers</b></p> <p>60</p> <p>50</p> <p>20</p>
<b>Measuring range</b>	<p>± 0.080mm <b>± .003"</b> ± 0.040mm <b>± .0015"</b> ± 0.020mm <b>± .00075"</b></p>		
<b>Data Output</b>			
<b>Battery Life</b>			
<b>Operating Temperature</b>			
<b>Storage Temperature</b>			
<b>Repeatability</b>			
<b>Calibration Accuracy</b>			
<b>Linear Error</b>			
<b>Response Time</b>			
<b>Thermal Stability</b>			
<b>Tolerance Indicators</b>			
<b>Weight</b>			
<b>Dimensions - Main body</b>			
<b>Auto Power Off</b>			
<b>Power Requirements</b>			
<b>Air Supply</b>			
<b>Display</b>			
<b>Order no.</b>			

\* Complete with handle, adaptor and hose

**Accessories**

	<b>μDimensionair II</b> Order no.	<b>Optional Factory</b> Configured Features for <b>μDimensionair II:</b>
<b>Pressure Regulator</b> with filter	<b>2238020*</b>	
<b>Pressure Meter</b>	<b>2095924</b>	
<b>Bench Kit</b> with adaptor	<b>2239307</b>	
<b>Battery</b> 3V type CR-2450	<b>EBY-1018</b>	
<b>Insulated Handle</b>	<b>2237666</b>	
<b>Shut off slide valve</b>	<b>2240993</b>	
<b>Rest Stand</b>	<b>2241109</b>	
<b>Swivel coupling adaptor</b>	<b>2240594</b>	
<b>Air Regulator Trap</b>	<b>AFL-24</b>	
<b>20' Long Hose</b>	<b>2237713</b>	
<b>Supply Hose</b> to Regulator/Filter	<b>AHO-2</b>	
<b>Data interface:</b>		
<b>USB Cable</b> (MarCom or PC, 2m)	<b>4346023</b>	
<b>RS232 Cable</b> (OPTO- 2m)	<b>4346020</b>	
<b>Digimatic Cable</b> (10 pin plug 2m)	<b>4346021</b>	

\* For applications where the local elevation is greater than 305 m / 1000 ft, special calibration is required.

**832 Dimensionair® Air Gaging** (Zero master system)

F



**Features**

- Digital and analog displays in a single unit. Large, high contrast digital readout shows exact deviation from zero; analog display shows measurement conditions at a glance
- Fixed resolution and balanced air system makes the Digital Dimensionair a stable and reliable system for manufacturing environments.
- Only a single master required to set zero; system is precalibrated for correct magnification
- Ranges and resolutions for virtually any air gage application, including 2-, 3-, 4- and 6-jet tooling plus AirProbes and JetProbes.
- Dynamics measurement capability
- RS-232 Output – for communicating with a data collector, computer or printer, permitting statistical process control
- Master Deviation – enhances measurement by making Auto Zero even more accurate.

**Technical Data**

Model	Measuring Range	Digital Resolution	Analog Resolution	Tooling I.D. Number
Low Magnification Single or Dual Input	$\pm 0.080 \text{ mm} / \pm .003''$	0.0002 mm / <b>10<math>\mu</math>''</b>	0.004 mm / <b>150<math>\mu</math>''</b>	60
	$\pm 0.040 \text{ mm} / \pm .0015''$		0.002 mm / <b>75<math>\mu</math>''</b>	50
	$\pm 0.020 \text{ mm} / \pm .00075''$		0.001 mm / <b>38<math>\mu</math>''</b>	20
High Magnification Single or Dual Input	$\pm 0.008 \text{ mm} / \pm .0003''$	0.0001 mm / <b>5<math>\mu</math>''</b>	0.0004 mm / <b>15<math>\mu</math>''</b>	10
	$\pm 0.004 \text{ mm} / \pm .00015''$		0.0002 mm / <b>8<math>\mu</math>''</b>	5

<b>Operating Temperature</b>	5~35° C / <b>41~95° F</b>
<b>Storage Temperature</b>	0~60° C / <b>32~140° F</b>
<b>Repeatability</b>	$\pm 1$ digit or $\pm 1\%$ of range, whichever is greater
<b>Calibration Accuracy</b>	$\pm 1$ digit*
<b>Linear Error</b>	$\pm 1$ digit
<b>Response Time (Electronics)</b>	43 msec.
<b>Response Time (Air)</b>	Approx. 1 sec. (dependent on hose length of air tooling)
<b>Thermal Stability</b>	0.1% of full scale/°F
<b>Digital I/O</b>	Five TTL opto-isolated outputs
<b>Data Output</b>	RS-232, transmits Channels A, B, (or both – dual input models only)
<b>Analog Output</b>	$\pm 5$ VDC full scale for displayed value signal $\pm A$ , $\pm B$
<b>Measuring Modes</b>	Actual, Minimum, Maximum, T.I.R., Nominal
<b>Tolerance Indicators</b>	Five LEDs
<b>Weight (approx.)</b>	5 kg / <b>11 lbs.</b>
<b>Dimensions H x W x D</b>	254 x 197 x 216 mm / <b>10" x 7.75" x 10.25"</b>
<b>Display Modes</b>	A, (or B or both – dual input models only)
<b>Auto Power Off</b>	After 30 minutes of non-use (selectable)
<b>Power Requirements</b>	100 Vac to 240 Vac, 50-60Hz with power module (Furnished)

*Note: All models listed may be ordered for: 1-Jet, 2-Jet, 3-Jet, 4-Jet, or 6-Jet applications. At time of ordering, PLEASE designate the number of jets to be used on the system.*

*\* For applications where the local elevation is greater than 305M/1000 feet, special calibration is required.*

## 832 Dimensionair® Air Gaging (Zero master system)

F

### Technical Data

Number of Jets	Voltage/Adaptor	Low Magnification Single Input Order no.	High Magnification Single Input Order no.	Low Magnification Dual Input Order no.	High Magnification Dual Input Order no.
1, 2, 3	110/U.S.	2004100	2004103	2004106	2004109
4	110/U.S.	2004101	2004104	2004107	2004110
6	110/U.S.	2004102	2004105	2004108	2004111
1, 2, 3	240/International	2004112	2004115	2004118	2004121
4	240/International	2004113	2004116	2004119	2004122
6	240/International	2004114	2004117	2004120	2004123

### Accessories

Order no.	Description
7024634	RS-232 Cable, Amplifier to MSP-2 Printer or computer, 2m / 6ft cable
ECV-1276	Oil/Splash Cover (opaque)—provides protection for the 832 Digital Dimensionair® when used in harsh environments
ECV-1285	Oil/Splash Cover (clear)—provides protection for the 832 Digital Dimensionair when used in harsh environments
ECB-1857	Footswitch for HOLD/RESUME, 3m / 10ft cable
ECB-1858	Footswitch for DYNAMIC RESET, 3 m / 10ft cable
ECB-1859	Footswitch for SEND DATA, 3m / 10ft cable
ECB-1855	Pushbutton for DYNAMIC RESET, 1.5m / 5ft cable
ECB-1860	Pushbutton for SEND DATA, 1.5m / 5ft cable
ECB-1868	Pushbutton for HOLD/RESUME and SEND DATA, 3m / 10ft cable
EKT-1236-W3	Relay Box – five relays each with Normally Open/Normally Closed contacts: Contact Rating – 30 Vdc/120 Vac, 3 amps Power Supply – 120 Vac Dimensions – 39 mm x 129 mm x 134.6 mm d/ 1.53" x 5.08" x 5.32" with ECB-1886-W2*, 6.1 mm / 24" interconnect cable amplifier/relay box
EKT-1236-W4	Same as W3, except with 220 Vac Power Supply
EKT-1236-W5	Same as W3, except with 240 Vac Power Supply
2010000	Power Supply, U.S. Adaptors (120V)
2010001	Power Supply, International Adaptor (120/240V)
<b>Mating Connectors</b>	
ECN-1695-W2	Digital I/O (15 pin male)
ECN-1693	Reset Data (3/32 microphone plug)
ECN-1695-W1	RS-232 Digital Output (9 pin female)

\* Order ECB-1886-W1 for 305 mm / 12" interconnect cable, or, ECB-1886-W3 for 914 mm / 36" cable.

**Millimar C 1208 PE** Compact, user-friendly length measuring unit



**Model types and Accessories**

			<b>Order no.</b>
<b>C1208 PE</b>	10000 F	Mahr Federal compatible	<b>5312093</b>
<b>C1208 PE</b>	2500 F/ 5000 F	Mahr Federal compatible	<b>5312095</b>

**Accessories**

<b>Connection cable</b> (9 pin D-Sub jack to D-Sub jack), length 3 m	<b>7024634</b>
<b>Control unit</b> with 3 push buttons	<b>5318430</b>
<b>Footswitch</b> for Millimar for	
Input 1	<b>5330955</b>
Input 2	<b>5330956</b>
Input 3	<b>5330957</b>
<b>Air Supply Adaptor Kit</b>	<b>2121236</b>

**Features**

**Functions**

- Favorites, using the SELECT button, frequently required settings can be directly called up
- Static measurements  $\pm A$ ,  $\pm B$  and all combinations
- Dynamic measurements: Max, Min, Max-Min, Max+Min, mean value
- Auto-detect mode. Two measuring devices can be connected (probe, plug gage. . .) - the measuring device used is automatically shown on the display
- 1 point or 2 point master measurements
- Programmable via built-in keypad or RS232 interface via MS-Windows configuration software D10005

**Display**

- Backlit LCD display with scale display and two-line digital display
- 5 three-colored status lamps for warning and tolerance limits
- Up to 2 features can be displayed at the same time

**Connections**

- One input for pneumatic measuring devices (optionally compatible to PE systems from Mahr or Mahr Federal)
- RS232 interface
- Three digital inputs for measuring start, master measurements, sending measuring value, . . .
- Three digital outputs for GO, NO-GO, rework, measuring time, . . .

**Technical Data**

Display Backlit LCD display 115 mm x 70 mm  
 Analog scale Indicator, 61 graduation  
 Range and text display Characters LCD, 5 x 7, Dot matrix, alpha numerical

Measured value display 7 digit LCD, 7 segments  
 Tolerance display 5 LEDs, 3 colors  
 Display ranges  $\pm 3, 10, 30, 100, 300, 1000, 3000, 10000 \mu\text{m}$   
 $\pm 0.0001, 0.0003; 0.001; 0.003; 0.01; 0.03; 0.1; 0.3 \text{ inch}$  or tolerance related

**Measuring range / resolution** (tooling dependant)  
 2500:1 100 ( $\pm 50$ )  $\mu\text{m}$  / 0.1  $\mu\text{m}$   
 5000:1 50 ( $\pm 25$ )  $\mu\text{m}$  / 0.1  $\mu\text{m}$   
 10000:1 25 ( $\pm 12.5$ )  $\mu\text{m}$  / 0.1  $\mu\text{m}$

**Error limits**  
 10 x analog display 2 % (51 pixel)  
 Digital display 0.05 %  
 Temperature coefficient  $\pm 0.005 \text{ \%}/^\circ\text{C}$   
 Operating temp. range 0  $^\circ\text{C}$  to 45  $^\circ\text{C}$

**Interfaces**

Computer, printer RS232, 9 pin, male (PC compatible configuration)  
 Control inputs 3 opto-coupler outputs, 24 V, 10 mA 24 V, 100 mA  
 Control outputs 3 opto-coupler inputs, 24 V, 100 mA 24V, 10 mA  
 Current supply 100 V to 240 V, 47 Hz to 63 Hz  
 Mains unit 10 VA  
 Power consumption 10 VA  
 Protection class IP53 with conductive dust IP43  
 Housing dimensions (H x W x D) ca. 205 x 160 x 165 mm  
 Weight ca. 2.1 kg

## Millimar C 1245 PE Flexible length measuring unit for versatile tasks (single or dual master system)



### Features

#### Display

- Analog indicator instrument for measuring value display
- Two-line LCD display to display the measuring value and help texts
- 5-color status lamps for warning and tolerance limits
- Up to 3 features can be shown simultaneously

#### Functions

- 16 characters can be defined
- With an equation editor (80 characters) input channels C1 to C8 are mathematically linked with factors and brackets using the 4 basic mathematical functions
- Static measurements: current value, square root, arc tangent
- Dynamic measurements: Max, Min, Max-Min, Max+Min, mean values
- Statistical functions: n, x-bar S, Xmax, Xmin, R
- Measuring value memory for 5000 measuring values
- Measuring Start / Stop via keyboard, digital input, RS232

#### Connections

- 2 input modules can be used in the basis unit
- RS232 interface
- 1 analog output
- 3 digital inputs for measuring start, master measurement / zeroing, sending data
- 6 digital outputs for GO, NO-GO, rework, collective goods, measuring time, 4 classes, BCD interface

### Model types

		Order no.
<b>C1245 PE/F</b>	2500 with regulator	<b>5331271</b>
<b>C1245 PE/F</b>	5000 with regulator	<b>5331271</b>
<b>C1245 PE/F</b>	10000 with regulator	<b>5331273</b>
For 2 pneumatic probes		
<b>C1245 PE/F 2</b>	2500 without regulator	<b>5331275*</b>
<b>C1245 PE/F 2</b>	5000 without regulator	<b>5331275*</b>
<b>C1245 PE/F 2</b>	10000 without regulator	<b>5331277*</b>

#### Accessories

<b>Air Supply Adaptor Kit</b>	<b>2121236</b>
<b>Baseplate*</b> with 2 regulators (req'd for PE/F 2 Units)	<b>5330909</b>

### Technical Data

Display	analog indicator instrument, LCD 53 mm x 40 mm
Analog scale	145 mm x 80 mm
Range and text display	7 characters LCD, 5x7 dot matrix, alphanumerical
Measured value display	7 characters LCD, 7 segment
Tolerance display	5 LEDs, 3-colored
Display ranges	± 10, 30, 100, 300, 1000, 3000, 10000 µm <b>± 0.0003; 0.001; 0.003; 0.01; 0.03; 0.1; 0.3 inch</b>

#### Measuring range / resolution (tooling dependant)

2500:1	100 (±50) µm / 0.1 µm
5000:1	50 (±25) µm / 0.1 µm
10000:1	25 (±12.5) µm / 0.1 µm

#### Error limits

10 x analog display	2 % (51 pixel)
Digital display	0.05 %

Temperature coefficient	± 0.005 %/°C
Operating temp. range	0 °C to 45 °C

#### Interfaces

Computer, printer	RS232, 9 pin, male (PC compatible configuration)
Control inputs	6 opto-coupler outputs, 24 V, 10 mA, 10 mA 24 V, 100 mA
Control outputs	3 opto-coupler inputs, 24 V, 100 mA
Current supply	90 V to 264 V,
Mains unit	47 Hz to 63 Hz
Power consumption	11 VA
Protection class	IP53 with conductive dust IP43
Housing dimensions (H x W x D)	ca. 205 x 160 x 165 mm
Weight	ca. 2.2 kg

**Millimar S 1840 PE** Length measuring instrument with three-color illuminated bar graph (single or dual master system)

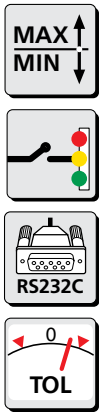

**Features**

Assess and judge measuring results at a glance – nothing is easier than that with the Millimar S 1840 column amplifier. For measurements with air measuring devices

The Millimar S 1840 column amplifier offers a broad range of functions for combining the signals from both static and dynamic measurements.

Measuring results are indicated by way of 101 three-color LEDs. When the programmable warning and tolerance limits are exceeded, the LEDs change their color from green to yellow or red, accordingly – high visibility from any distance.

**Display**

- Easy to read 3-color illuminated bar graph with analog warning and tolerance limit display
- Backlit, two-line LCD for the display of measuring values, help tests and units of measurement
- Up to two characteristics can be displayed simultaneously.

**Connections**

- Single input.
- RS 232 interface.
- Analog output.
- Three digital inputs for measuring start, master measurement, etc.
- Three digital outputs for Accept – Reject – Rework classification, measuring time, etc.

**Functions**

- Dynamic measurements: Max, Min, Max-Min, Max+Min, mean.
- Windows® software for configuring the LED display The Millimar S 1840 column amplifier can be programmed either menu-guided via the integrated membrane keypad or with the provided Microsoft Windows® configuration software.
- Single Master or Dual Master setup.
- Password lockout in Setup Mode.

- Supplied with:  
Mains power supply plug

**Configuration Software**

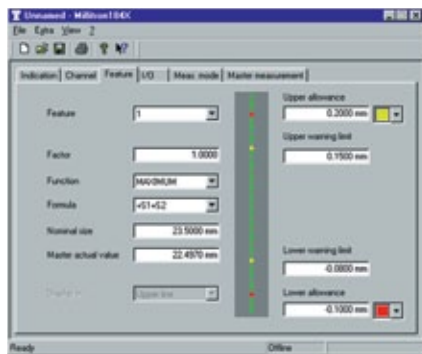

The Millimar S 1840 column amplifier can be programmed either menu-guided via the integrated membrane keypad or with the provided Microsoft Windows® configuration software.



Shown with 2239307 stand

**Millimar S 1840 PE** Length measuring instrument with three-color illuminated bar graph (single or dual master system)

**Technical Data**

Analog display 101 LED elements, 3-color  
 Range and text display 7 character LCD, 14 segment, alphanumerical  
 Measured value display 7-stellig LCD, 7 Segment  
 Tolerance display via color range of the analog display  
 Display ranges ± 1, 10, 30, 100, 300, 1000, 3000, 10000 µm  
**± .0001; .0003; .001; .003; .01; .03; .1; .3 inch** or tolerance related

**Error limits**

10 x analog display 1 % (101 LEDs)  
 Digital display ± 1 digit  
 Temperature coefficient ± 0.005 %/°C  
 Operating temp. range 0 °C to 45 °C

**Interfaces**

Computer, printer RS232, 9 pin, male (PC compatible configuration)  
 Control inputs 3 opto-coupler outputs, 24 V, 10 mA  
 Control outputs 3 opto-coupler inputs, 24 V, 100 mA  
 Analog output voltage 1 V/mm  
 Power supply 90 V bis 264 V, 47 Hz to 63 Hz  
 Power consumption 20 VA  
 Protection class IP53 with conductive dust IP43  
 Housing dimensions (H x W x D) ca. 487 x 47 x 144 mm  
**ca. 19.17" x 1.85" x 5.67"**  
 Weight ca. 1.6 kg

**Air/electronic converter for Millimar S 1840 PE**

Measuring principle	differential pressure		
Measuring value acquisition	piezo		
Magnification	2500:1	5000:1	10000:1
Air measuring range in µm ( <b>inch</b> )	± 50 ( <b>±.00196"</b> )	± 25 ( <b>±.00098"</b> )	± 12.5 ( <b>±.00049"</b> )
Resolution	0.1 µm / <b>.000005"</b>		
Measuring error in µm ( <b>inch</b> )	< 1 % of measuring range, better 0.5 %		
Signal noise in µm ( <b>µinch</b> )	≤ 0.4 ( <b>15.748</b> )	≤ 0.2 ( <b>7.874</b> )	≤ 0.1 ( <b>3.937</b> )
Setting time in sec. (1 m / 3.3 ft hose)	≤ 0.3	≤ 0.3	≤ 0.5
Setting time in sec. (2 m / 6.6 ft hose)	≤ 0.5	≤ 0.5	≤ 0.7
Operating temperature	0 ... 40 °C (32 ... 104 °F)		
Supply pressure (> 4 bar before regulator)	2 bar ± 5 %		
Air supply connection	PU hose, dia 8 x 1 ( <b>.315 x .0394"</b> )		
Measuring air connection	PU hose, dia. 6 x 1 ( <b>.236 x .0394"</b> )		
Zero setter (OFFSET)	electrical		
Amplification (GAIN)	electrical		
Air consumption	approx. 1-2 m <sup>3</sup> ( <b>1.308-2.616 cu.yd.</b> )		

**Order no.**

<b>Millimar S 1840 PE to connect air measuring devices</b>			
		<b>Tooling I.D.</b>	<b>Order no.</b>
<b>S 1840 PE/F</b>	Low magnification for 1 air gage 2500:1 / 5000:1 without regulator	50/20	<b>5318455*</b>
<b>S 1840 PE/F</b>	High magnification for 1 air gage 10000:1 without regulator	10,5	<b>5318457*</b>

\* Base with Regulator required and sold separately, Air Supply Kit recommended

**Accessories**

	<b>Order no.</b>
<b>Base Foot</b> With 1 Regulator for 1 1840 PE Column Unit	<b>5330914</b>
<b>Base Foot</b> With 2 Regulators for 2 1840 PE Column Units	<b>5330915</b>
<b>Base Foot</b> With 3 Regulators for 3 1840 PE Column Units	<b>5330916</b>
<b>Connection Cable</b> (9 pin D-Sub jack to D-Sub jack), length 3 m	<b>7024634</b>
<b>Control Unit</b> with 3 push buttons	<b>5318430</b>
<b>Foot Switch</b> for Millimar	<b>5330955</b>
<b>Configuration Software</b> D1000 S	<b>7090375</b>
<b>Air Supply Adaptor Kit</b> Includes AFL-24 Filter and AHO-2 Hose	<b>2121236</b>
<b>Splash cover</b>	<b>2247956</b>

# Millimar. Air Gages

## PRECISION BEGINS AT THE START OF THE MEASURING PROCESS

► | Air gages use the measuring effect of the change in pressure when a workpiece approaches a measuring jet. As the distance between jets and work surface decreases, the pressure increases while the velocity of flow and the respective volume flow decrease. The air measuring procedure has a relatively short but very linear measuring range. | ◀

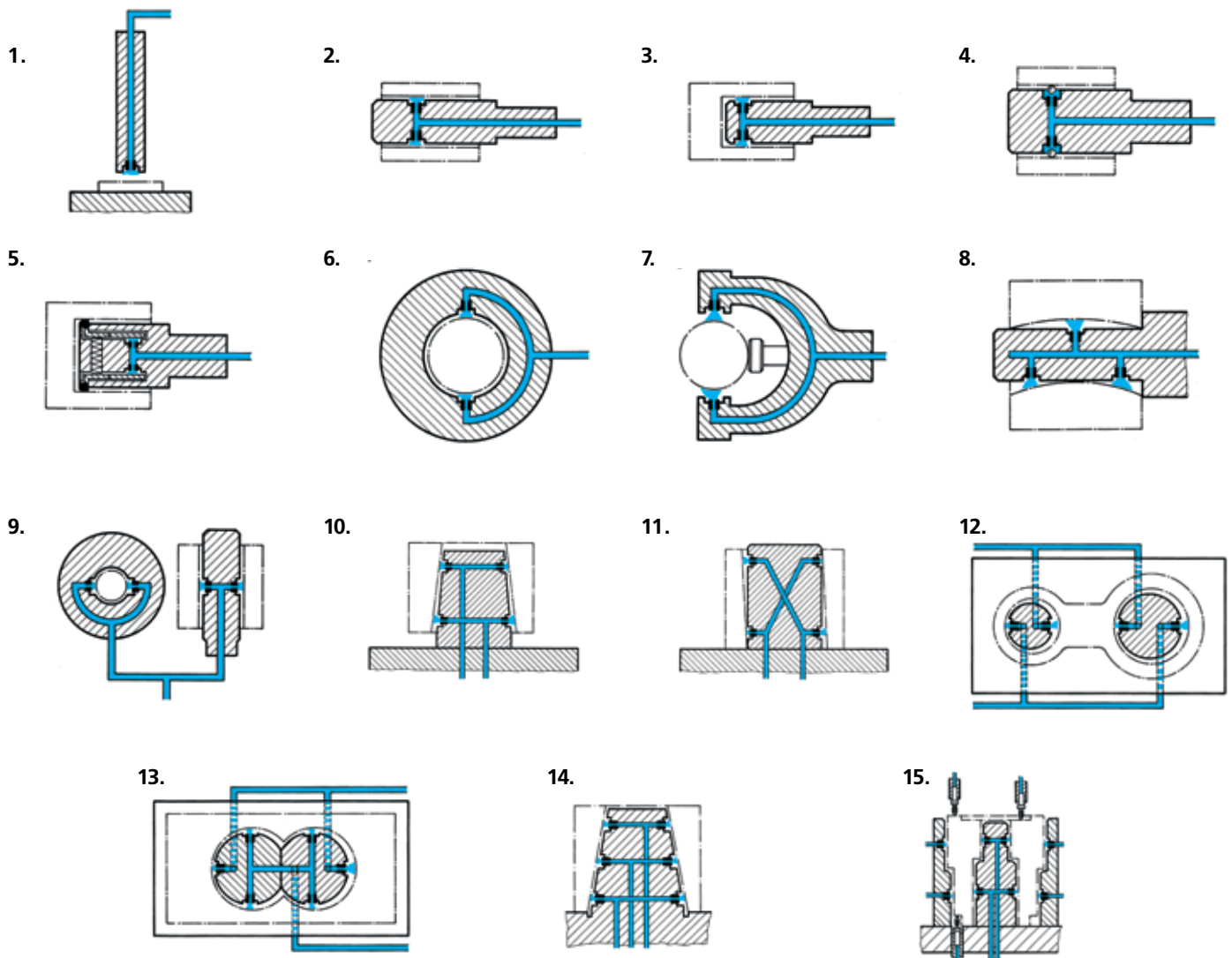

**1.** Thickness or wall thickness measurements with jet air gage **2.** Diameter measurement of cylindrical through bores with jet air plug gage. **3.** Diameter measurement of cylindrical blind bores with jet air plug gage. **4.** Diameter measurement of cylindrical through bores with ball contact plug gage **5.** Diameter measurement of cylindrical blind bores with lever contact plug gage **6.** Diameter of thickness measurement with adjustable jet air caliper gage **8.** Straightness measurement of a cylindrical bore with special jet air plug gage **9.** Mating measurement between bore and shaft with jet air plug gage and jet air ring gage. **10.** Taper-pitch measurement of an inside taper with taper jet air plug gage measurement as per the differential measuring method **11.** Measurement of a perpendicular position of a cylindrical bore to the front face with a special jet air plug gage measurement as per the differential measuring method **12.** Measurement of hole distances of separated cylindrical bores with jet air plug gage measurement as per the differential measuring method **13.** Measurement of hole distances of truncated cylindrical bores with jet air plug gages measurement as per the differential measuring method **14.** Taper-pitch measurement as well as form and diameter measurement of an inside taper with taper jet air plug gage. **15.** Multiple inside and outside measurements with measuring jet air gages and contact probes in connection with a seven-column unit.



## Dimensionair® Air Gages – Air Plugs

### Features

- **Calibrated I.D. tooling for the Dimensionair® Air Gaging Systems**
- Tooling is interchangeable without adjusting system magnification.
- Federal Air Plugs have large clearance (see table below), allowing easy entrance into the hole being measured and greater measuring range.
- Long life - wide clearance and hard chrome (optional) body extends useful life of the Air Plug.
- Deep, recessed jets - Air jets are recessed into the plug body which protects them from damage.
- Large jet size eliminates clogging from dirt and oils.

### Plug identification



Air Plugs are marked with an identification number which identifies its size, number of jets, plug style, and the Dimensionair® Model the plug should be used with.

For example: **DP50-T2-1.000** is the identification number of an Air Plug for a **2095184** or a standard magnification 832 Dimensionair (DP50), through-hole style with two jets (-T2), and 25mm/1.000" nominal size (-1.000).

The number (50) which identifies the Dimensionair intended is marked on the plug and also appears on the dial of the Dimensionair to help in matching the tooling to its corresponding Dimensionair Model.

Identification	Nominal Size from		To & include		Clearance from Nominal Size	
	mm	inch	mm	inch	mm	inch
<b>DP100*, DP60</b>	3	.123"	3.5	.140"	0.030	.0012"
	3.5	.140"	4.7	.185"	0.045	.0018"
	4.7	.185"	6.3	.248"	0.061	.0024"
	6.3	.248"	76.3	3.004"	0.081	.0032"
	76.3	3.004"	127	5.000"	0.089	.0035"
	above 127	5.000"			0.107	.0042"
<b>DP50</b>	3	.123"	3.5	.140"	0.015	.0006"
	3.5	.140"	4.7	.185"	0.027	.0011"
	4.7	.185"	6.3	.248"	0.030	.0012"
	6.3	.248"	76.3	3.004"	0.045	.0018"
	76.3	3.004"	127	5.000"	0.071	.0028"
	Above 127	5.000"			0.081	.0032"
<b>DP20</b>	3	.123"	3.5	.140"	0.009	.00035"
	3.5	.140"	4.7	.185"	0.013	.0005"
	4.7	.185"	6.3	.248"	0.015	.0006"
	6.3	.248"	76.3	3.004"	0.023	.0009"
	76.3	3.004"	127	5.000"	0.071	.0028"
	Above 127	5.000"			0.081	.0032"
<b>DP10</b>	1.57	.062"	44.5	1.750"	0.009	.00035"
	44.5	1.750" up			0.014	.00055"
<b>DP5</b>	1.57	.062"	25.40	1.000"	0.004	.000175"
	25.40	1.000"	44.45	1.750"	0.005	.0002"
	44.45	1.750" up			0.007	.0003"

\* DP-100 not available below 9.525 mm / .375"

### Ordering Information

When ordering Air Plugs please specify:

1. Nominal I.D. Size and Tolerance.
2. Dimensionair Model to be used.
3. Air Plug style (Through Hole, Blind Hole, or Counterbore).
4. Air Plug finish (Chrome-plated or Hardened Steel).
5. Order Master Setting Ring at same time.

Unless otherwise specified, Mahr Federal will furnish a 2-jet, Through Hole, High Chrome Air Plug for a 2500:1 Dimensionair.



Through Hole and Blind Hole Air Plugs

## Through Hole Plugs (DP50 - DP20 & 60)

### 3.12-4.70 mm / .123-.185"

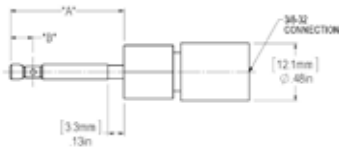

Minimum recommended hole length: 4.75 mm / **.187"**

### 14.94-19.05 mm / .588-.750"

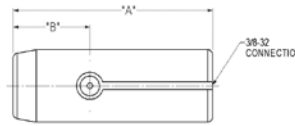

Minimum recommended hole length: 6.35 mm / **.250"**  
 With guide sleeve or stop collar: 1.8 mm / **.070"**  
 May be used with AHA-4 or -5 Extensions for deep holes.

### 4.70-6.30 mm / .185-.248"

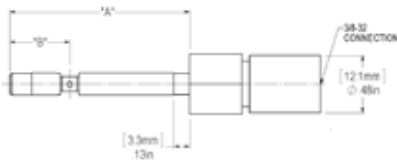

Minimum recommended hole length: 4.75 mm / **.187"**

### 19.05-37.69 mm / .750-1.484"

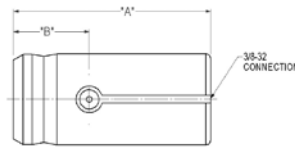

Minimum recommended hole length: 6.35 mm / **.250"**  
 With guide sleeve or stop collar: 1.8 mm / **.070"**  
 May be used with AHA-4 or -5 Extensions for deep holes.

### 6.30-9.49 mm / .248-.3735"

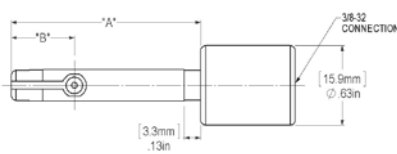

Minimum recommended hole length: 6.35 mm / **.250"**

### 37.69-76.30 mm / 1.484-3.004"

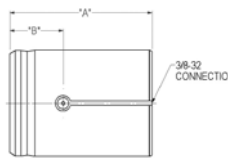

Minimum recommended hole length: 6.35 mm / **.250"**  
 With guide sleeve or stop collar: 1.8 mm / **.070"**  
 May be used with AHA-4 or -5 Extensions for deep holes.

### 9.49-14.94 mm / .3735-.588"

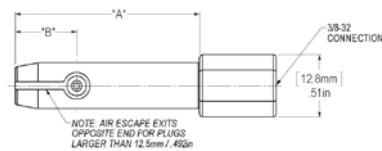

Minimum recommended hole length: 6.35 mm / **.250"**

### 76.30-114.30 mm / 3.004-4.500"

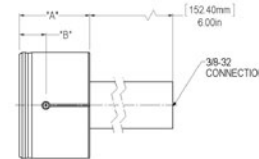

Minimum recommended hole length: 6.35 mm / **.250"**  
 With guide sleeve or stop collar: 1.8 mm / **.070"**

With guide sleeve or stop collar: 1.8 mm / **.070"**  
 May be used with AEX-1 or -2 Extensions for deep holes.

## Technical Data

### Through Hole Plugs

#### Measured Size mm *inch*

	Above	To & include	"A"	"B"	Minimum Hole Length*	Measuring Range		
						DP50	DP20	DP60
3.12	<b>.123"</b>	3.56 <b>.140"</b>	23.81 <b>.938"</b>	4.76 <b>.188"</b>	4.75 <b>.187"</b>	0.025 <b>.0010"</b>	0.013 <b>.0005"</b>	0.051 <b>.0020"</b>
3.56	<b>.140"</b>	4.70 <b>.185"</b>	23.81 <b>.938"</b>	4.76 <b>.188"</b>	4.75 <b>.187"</b>	0.038 <b>.0015"</b>	0.0200 <b>.00075"</b>	0.076 <b>.0030"</b>
4.70	<b>.185"</b>	6.30 <b>.248"</b>	38.10 <b>1.500"</b>	12.70 <b>.500"</b>	4.75 <b>.187"</b>	0.051 <b>.0020"</b>	0.025 <b>.001"</b>	0.102 <b>.0040"</b>
6.30	<b>.248"</b>	9.49 <b>.3735"</b>	38.10 <b>1.500"</b>	12.70 <b>.500"</b>	6.35 <b>.250"</b>	0.076 <b>.0030"</b>	0.038 <b>.0015"</b>	0.152 <b>.0060"</b>
9.49	<b>.3735"</b>	14.94 <b>.588"</b>	38.10 <b>1.500"</b>	12.70 <b>.500"</b>	6.35 <b>.250"</b>	0.076 <b>.0030"</b>	0.038 <b>.0015"</b>	0.152 <b>.0060"</b>
14.94	<b>.588"</b>	19.05 <b>.750"</b>	41.28 <b>1.625"</b>	15.88 <b>.625"</b>	6.35 <b>.250"</b>	0.076 <b>.0030"</b>	0.038 <b>.0015"</b>	0.152 <b>.0060"</b>
19.05	<b>.750"</b>	37.69 <b>1.484"</b>	41.28 <b>1.625"</b>	15.88 <b>.625"</b>	6.35 <b>.250"</b>	0.076 <b>.0030"</b>	0.038 <b>.0015"</b>	0.152 <b>.0060"</b>
37.69	<b>1.484"</b>	76.30 <b>3.004"</b>	50.80 <b>2.000"</b>	19.10 <b>.750"</b>	6.35 <b>.250"</b>	0.076 <b>.0030"</b>	0.038 <b>.0015"</b>	0.152 <b>.0060"</b>
76.30	<b>3.004"</b>	114.30 <b>4.5"</b>	50.80 <b>2.000"</b> **	19.10 <b>.750"</b>	6.35 <b>.250"</b>	0.076 <b>.0030"</b>	0.038 <b>.0015"</b>	0.152 <b>.0060"</b>

\* If a guide sleeve or stop collar is used, minimum hole length can be as small as 1.78 mm / .070" for holes larger than 6.30 mm / .248".

\*\* A handle 152 mm / 6" long and 33.3 mm / 1.31" diameter is supplied with plugs over 76.5 mm / 3.004".

## Blind Hole/Counterbore Plugs (DP50 - DP20 & 60)

### 3.94-4.7 mm / .155-.185"

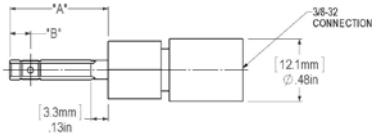

Minimum recommended hole length: 6.35 mm / **.250"**  
 Note: Masters must simulate workpiece for holes of this size.

### 11.86-14.94 mm / .467-.588"

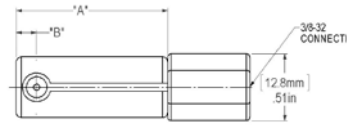

Minimum recommended hole length: 6.35 mm / **.250"**  
 Shorter bores can be checked. Consult Mahr Federal Customer Resource Center. May be used with Extensions AEX-1 or -2 for deep holes.

### 4.7-6.30 mm / .185-.248"

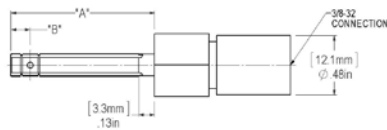

Minimum recommended hole length: 6.35 mm / **.250"**

### 14.94-37.69 mm / .588-1.484"

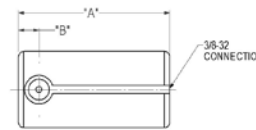

Minimum recommended hole length: 6.35 mm / **.250"**  
 Shorter bores can be checked. Consult Mahr Federal Customer Resource Center. May be used with AHA-4 or -5 Extensions for deep holes.

### 6.30-9.49 mm / .248-.3735"

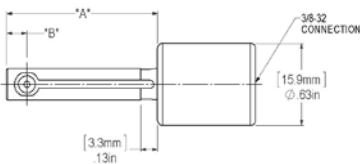

Minimum recommended hole length: 6.35 mm / **.250"**  
 Shorter bores can be checked. Consult Mahr Federal Customer Resource Center.

### 37.69-76.30 mm / 1.484-3.004"

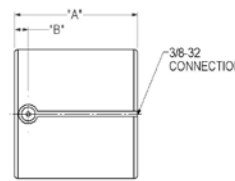

Minimum recommended hole length: 6.35 mm / **.250"**  
 Shorter bores can be checked. Consult Mahr Federal Customer Resource Center. May be used with AHA-4 or -5 Extensions for deep holes.

### 9.49-11.86 mm / .3735-.467"

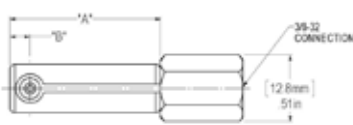

Minimum recommended hole length: 6.35 mm / **.250"**. Shorter bores can be checked. Consult Mahr Federal Customer Resource Center. May be used with Extension AHA-28 for deep holes.

### 76.30-114.30 mm / 3.004-4.50"

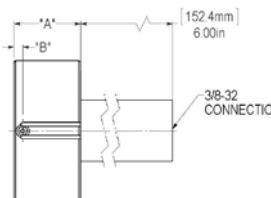

Minimum recommended hole length: 6.35 mm / **.250"**.

### Super Blind Plugs

Blind Hole Air Plugs can be furnished to check shorter holes than listed above, and can be furnished to check closer to the bottom of a hole. Holes must be at least 2.79 mm/.110" long, and the distance from the end of the plug to the center-line of the jets can be as short as 2.16 mm/.085" for plugs below 6.3 mm/.248" or 1.90 mm/.075" for plugs above 6.3 mm/.248".

## Blind Hole/Counterbore Plugs

mm <i>inch</i>								Minimum Hole Length*		Measuring Range DP50		DP20	DP60		
Above	To & Include	"A"	"B"												
3.94	<b>.155"</b>	4.70	<b>.185"</b>	19.10	<b>.750"</b>	3.96	<b>.156"</b>	6.35	<b>.250"</b>	0.038	<b>.0015"</b>	0.200	<b>.00075"</b>	.076	<b>.0030"</b>
4.70	<b>.185"</b>	6.30	<b>.248"</b>	29.36	<b>1.156"</b>	3.96	<b>.156"</b>	6.35	<b>.250"</b>	0.051	<b>.0020"</b>	0.025	<b>.0010"</b>	.102	<b>.0040"</b>
6.30	<b>.248"</b>	9.49	<b>.3735"</b>	29.36	<b>1.156"</b>	3.96	<b>.156"</b>	6.35	<b>.250"</b>	0.076	<b>.0030"</b>	0.038	<b>.0015"</b>	.152	<b>.0060"</b>
9.49	<b>.3735"</b>	11.86	<b>.467"</b>	29.36	<b>1.156"</b>	3.96	<b>.156"</b>	6.35	<b>.250"</b>	0.076	<b>.0030"</b>	0.038	<b>.0015"</b>	.152	<b>.0060"</b>
11.86	<b>.467"</b>	14.94	<b>.588"</b>	29.36	<b>1.156"</b>	3.96	<b>.156"</b>	6.35	<b>.250"</b>	0.076	<b>.0030"</b>	0.038	<b>.0015"</b>	.152	<b>.0060"</b>
14.94	<b>.588"</b>	37.69	<b>1.484"</b>	29.36	<b>1.156"</b>	3.96	<b>.156"</b>	6.35	<b>.250"</b>	0.076	<b>.0030"</b>	0.038	<b>.0015"</b>	.152	<b>.0060"</b>
37.69	<b>1.484"</b>	76.30	<b>3.004"</b>	35.71	<b>1.406"</b>	3.96	<b>.156"</b>	6.35	<b>.250"</b>	0.076	<b>.0030"</b>	0.038	<b>.0015"</b>	.152	<b>.0060"</b>
76.30	<b>3.004"</b>	114.3	<b>4.5"</b>	38.10	<b>1.5"*/**</b>	3.96	<b>.156"</b>	6.35	<b>.250"</b>	0.076	<b>.0030"</b>	0.038	<b>.0015"</b>	.152	<b>.0060"</b>

\* If a guide sleeve or stop collar is used, minimum hole length can be as small as 1.78 mm / .070" for holes larger than 6.30 mm / .248".

\*\* A handle 152 mm/6" long and 33.3 mm/1.31" diameter is supplied with plugs over 76.30 mm / 3.004".

## Through Hole Plug (DP10 – DP5)

### 1.57-6.35 mm / .062-.250"

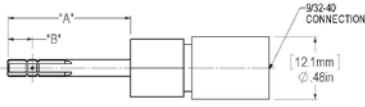

Minimum recommended hole length: 3.18 mm / **.125"**.

### 6.35-9.49 mm / .250-.3735"

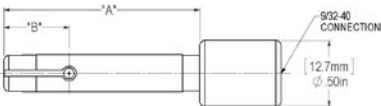

Minimum recommended hole length: 3.18 mm / **.125"**.  
With guide sleeve or stop collar: 1.14 mm / **.045"**.

### 9.49-11.10 mm / .3735-.437"

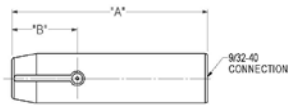

Minimum recommended hole length: 3.18 mm / **.125"**.  
With guide sleeve or stop collar: 1.14 mm / **.045"**. May be used with AHA-23 or -24 Extensions for deep holes.

### 11.10-19.05 mm / .437-.750"

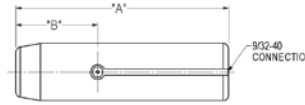

Minimum recommended hole length: 3.18 mm / **.125"** with proper support min. is 1.14 mm / **.045"**. May be used with AHA-23 or -24 Extensions for deep holes.

### 19.05-44.45 mm / .750-1.750"

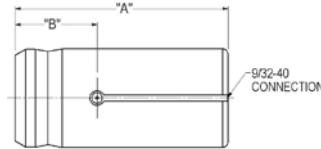

Minimum recommended hole length: 3.18 mm / **.125"**.  
With guide sleeve or stop collar: 1.14 mm / **.04"**. May be used with AHA-23 or -24 Extensions for deep holes.

### 44.45-76.45 mm / 1.750-3.010"

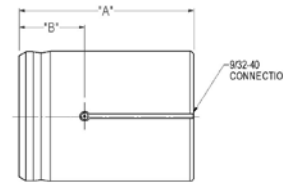

Minimum recommended hole length: 3.18 mm / **.125"**.  
With guide sleeve or stop collar: 1.14 mm / **.04"**. May be used with AHA-23 or -24 Extensions for deep holes.

## Through Hole Plugs mm / inch

Above		To & include		"A"		"B"		Minimum Hole Length*		Measuring Range			
										DP10	DP5		
1.57	<b>.062"</b>	6.35	<b>.250"</b>	23.81	<b>.938"</b>	4.76	<b>.188"</b>	3.18	<b>.125"</b>	0.015	<b>.0006"</b>	0.008	<b>.0003"</b>
6.35	<b>.250"</b>	9.49	<b>.3735"</b>	38.10	<b>1.500"</b>	12.70	<b>.500"</b>	3.18	<b>.125"</b>	0.015	<b>.0006"</b>	0.008	<b>.0003"</b>
9.49	<b>.3735"</b>	11.10	<b>.437"</b>	41.28	<b>1.625"</b>	15.88	<b>.625"</b>	3.18	<b>.125"</b>	0.015	<b>.0006"</b>	0.008	<b>.0003"</b>
11.10	<b>.437"</b>	19.05	<b>.750"</b>	41.28	<b>1.625"</b>	15.88	<b>.625"</b>	3.18	<b>.125"</b>	0.015	<b>.0006"</b>	0.008	<b>.0003"</b>
19.05	<b>.750"</b>	44.45	<b>1.750"</b>	41.28	<b>1.625"</b>	15.88	<b>.625"</b>	3.18	<b>.125"</b>	0.015	<b>.0006"</b>	0.008	<b>.0003"</b>
44.45	<b>1.750"</b>	76.45	<b>3.010"</b>	50.80	<b>2.000"</b>	2.000	<b>.625"</b>	3.18	<b>.125"</b>	0.015	<b>.0006"</b>	0.008	<b>.0003"</b>

## Blind Hole Plug (DP10 – DP5)

### 3.18-6.35 mm / .125-.250"

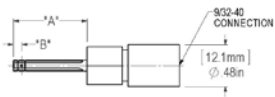

Minimum recommended hole length: 3.96 mm / **.156"**.

### 6.35-11.10 mm / .250-.437"

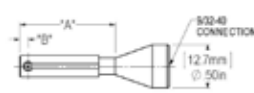

Minimum recommended hole length: 3.18 mm / **.125"**.

### 11.10-76.45 mm / .437-3.010"

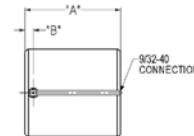

Minimum recommended hole length: 3.18 mm / **.125"**.  
Use AHA-23 or -24 Extensions for deep hole applications.

## Blind Hole/Counterbore Plugs

Above		To & include		"A"		"B"		Minimum Hole Length*		Measuring Range			
										DP10	DP5		
mm	<b>inch</b>	mm	<b>inch</b>	mm	<b>inch</b>	mm	<b>inch</b>	mm	<b>inch</b>	mm	<b>inch</b>		
3.18	<b>.125"</b>	6.35	<b>.250"</b>	21.44	<b>.844"</b>	2.39	<b>.094"</b>	3.96	<b>.156"</b>	.015	<b>.0006"</b>	.008	<b>.0003"</b>
6.35	<b>.250"</b>	11.10	<b>.437"</b>	27.79	<b>1.094"</b>	2.39	<b>.094"</b>	3.05	<b>.120"</b>	.015	<b>.0006"</b>	.008	<b>.0003"</b>
11.10	<b>.437"</b>	76.45	<b>3.010"</b>	27.79	<b>1.094"</b>	2.39	<b>.094"</b>	3.05	<b>.120"</b>	.015	<b>.0006"</b>	.008	<b>.0003"</b>

\* If a guide sleeve or stop collar is used, minimum hole length can be as small as 1.1 mm / **.045"** for holes larger than 6.4 mm / **.250"**.

## Super Blind Plugs

Blind Hole Air Plugs can be furnished to check shorter holes than listed above, and can be furnished to check closer to the bottom of a hole. Holes must be at least 1.9 mm / **.075"** long, and the distance from the end of the plug to the center-line of the jets can be as short as 1.4 mm / **.055"** for plugs below 6.4 mm / **.250"** or 1.1 mm / **.045"** for plugs above 6.4 mm / **.250"**.

## Through Hole Plug (DP100)

9.53-12.70 mm / .375-.500"

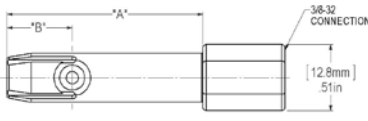

Minimum recommended hole length: 6.35 mm / **.250"**, with proper support min. is 3.18 mm / **.125"**. May be used with AEX-1 or -2 Extensions for deep holes.

37.85-76.30 mm / 1.490-3.004"

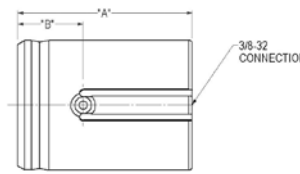

Minimum recommended hole length: 6.35 mm / **.250"**. May be used with AHA-4 or -5 Extensions for deep holes.

12.70-19.05 mm / .500-.750"

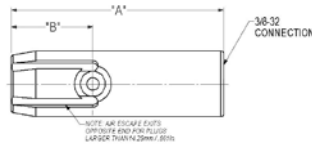

Minimum recommended hole length: 6.35 mm / **.250"**, with proper support min. is 1.14 mm / **.125"**. May be used with AHA-4 or -5 Extensions for deep holes.

76.30-114.30 mm / 3.004-4.500"

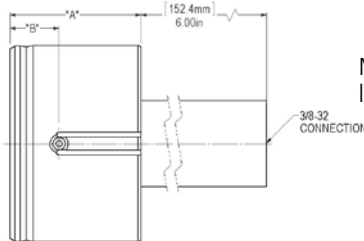

Minimum recommended hole length: 6.35 mm / **.250"**.

19.05-37.85 mm / .750-1.490"

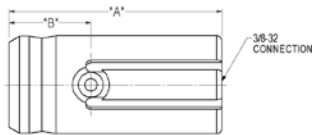

Minimum recommended hole length: 6.35 mm / **.250"**, with proper support min. is 1.14 mm / **.125"**. May be used with AHA-4 or -5 Extensions for deep holes.

## Through Hole Plugs

### Measured Size mm/inch

	Above	To & include	"A"	"B"	Minimum Hole Length*	Measuring Range					
9.53	<b>.375"</b>	12.70	<b>.500"</b>	38.10	<b>1.500"</b>	12.70	<b>.500"</b>	6.35	<b>.250"</b>	.152	<b>.006"</b>
12.70	<b>.500"</b>	19.05	<b>.750"</b>	41.28	<b>1.625"</b>	15.88	<b>.625"</b>	6.35	<b>.250"</b>	.152	<b>.006"</b>
12.70	<b>.500"</b>	37.85	<b>1.490"</b>	41.28	<b>1.625"</b>	15.88	<b>.625"</b>	6.35	<b>.250"</b>	.152	<b>.006"</b>
37.85	<b>1.490"</b>	76.30	<b>3.004"</b>	50.80	<b>2.000"</b>	19.05	<b>.750"</b>	6.35	<b>.250"</b>	.152	<b>.006"</b>
76.30	<b>3.004"</b>	114.30	<b>4.500"</b>	50.80	<b>2.000"</b>	19.05	<b>.750"</b>	6.35	<b>.250"</b>	.152	<b>.006"</b>

## Blind Hole/Counterbore Plugs

9.53-14.25 mm / .375-.561"

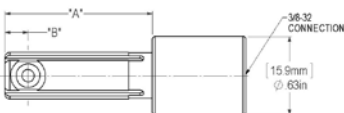

Minimum recommended hole length: 7.92 mm / **.312"**.

14.25-37.85 mm / .561-1.490"

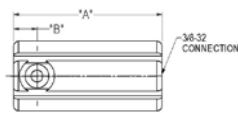

Minimum recommended hole length: 7.92 mm / **.312"**. Use with AHA-4 or -5 handles for deep hole applications.

37.85-76.30 mm / 1.490-3.004"

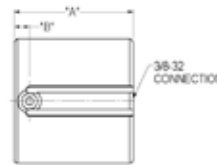

Minimum recommended hole length: 7.92 mm / **.312"**. Use with AHA-4 or -5 handles for deep hole applications.

76.30-114.30 mm / 3.004-4.500"

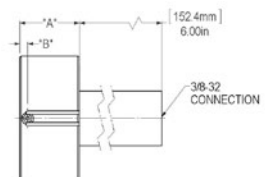

Minimum recommended hole length: 7.92 mm / **.312"**.

### Super Blind Plugs

Blind Hole Air Plugs can be furnished to check shorter holes than listed above, and can be furnished to check closer to the bottom of a hole. Holes must be at least 4.45 mm / **.175"** long, and the distance from the end of the plug to the centerline of the jets can be as short as 2.5 mm / **.100"**.

### Blind Hole Plugs

#### Measured Size mm/inch

	Above	To & include	"A"	"B"	Minimum Hole Length*	Measuring Range					
9.53	<b>.375"</b>	14.25	<b>.561"</b>	30.15	<b>1.187"</b>	4.75	<b>.187"</b>	7.92	<b>.312"</b>	.152	<b>.0060"</b>
14.25	<b>.561"</b>	37.85	<b>1.490"</b>	30.15	<b>1.187"</b>	4.75	<b>.187"</b>	7.92	<b>.312"</b>	.152	<b>.0060"</b>
37.85	<b>1.490"</b>	76.30	<b>3.004"</b>	36.53	<b>1.438"</b>	4.75	<b>.187"</b>	7.92	<b>.312"</b>	.152	<b>.0060"</b>
76.30	<b>3.004"</b>	114.30	<b>4.500"</b> **	36.53	<b>1.438"</b>	4.75	<b>.187"</b>	7.92	<b>.312"</b>	.152	<b>.0060"</b>

Notes:

\* If a guide sleeve or stop collar is used, minimum hole length can be as small as 3.18 mm/.125"

\*\* A handle 152 mm/6" long and 33.3 mm/1.31" diameter is supplied with plugs over 76.3 mm/3.004". For smaller or larger plugs than those shown above, or for any modification to the specifications shown, contact Mahr Federal Customer Resource Center.

## Air Gaging Instruments

### Accessories

#### Handles and Extensions

When an Air Plug is used with a hose, it should be equipped with a Handle to avoid excessive strain on the air connection and corrosion on the polished plug body. Handles may be combined for gaging deep holes.

Selection of a handle or extension is determined by the bore itself and whether or not it is preceded by a larger C-bored diameter. Corresponding thread sizes of the handle or extension must also be considered.

If no portion of the handle or extension enters the part, only thread sizes must be considered. If the plug does enter the part, then both O.D. and thread size must be considered.

**2202010 and 2202011 Extensions** — accept 2202074 Hose on one end and the following plug sizes on the opposite end: all 1250:1 thru 8000:1 plugs up to 76.3 mm / **3.004"**.

**2202012 Handle** — accepts 2202074 Hose on one end and the following plug sizes on the opposite end: all 1250:1 thru 8000:1 plugs up to 76.3 mm / **3.004"**. Has Bakelite insulating cover. Recommended for 37.7 mm / **1.484"** up to 76.3 mm / **3.004"** diameters.

**2237666** — High impact and coolant resistant, light weight composite handle — normally furnished with  $\mu$ Dimensionair and air snaps.

**2202012 and 2236070** — light weight aluminum handles without or with air shutoff valve.

**2202003 Handle** — Used and furnished with 1250:1 thru 8000:1 through or blind hole plugs over 76.3 mm / **3.004"**.

**2202007 and 2202008 Handles** — Used with 10000:1 thru 32000:1 plugs.

**2202009 Handle** — Used with 2500:1 thru 8000:1 blind hole plugs in the 9.47 mm / **.3735"** to 11.8 mm / **.467"** range, using an 2201588 Adaptor.

**2201954 and 2201963 Extensions** — Used with 2500:1 thru 8000:1 through hole air plugs in the 9.47 mm / **.3735"** to 14.93 mm / **.588"** range and with 11.8 mm / **.467"** to 14.93 mm / **.588"** range blind hole plugs, using an 2201601 Adaptor.

**2201975** — extension used with 2204599 adjustable base. Provides easily configured base for bench-mounted air tooling fixturing. See Dimention Plugs (Chapter 9. MaraMeter).

#### Accessory Configuration for DP60/DP50/DP20 Systems — Low Magnification

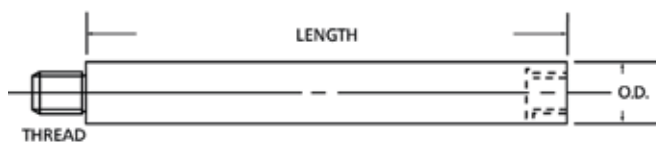
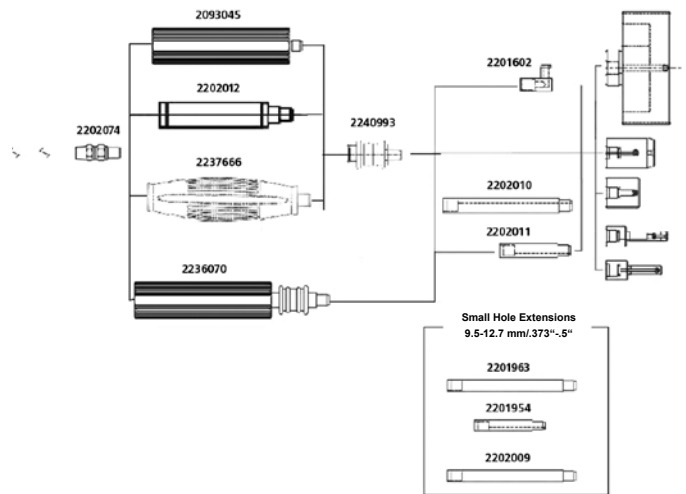

Order no.	Thread	O.D.		Length	
		mm	inch	mm	inch
2202010	3/8-32	12.07	.475"	102	4"
2202011	3/8-32	12.07	.475"	51	2"
2202012	3/8-32	25.4	1.00"	102	4"
2202003	1-1/8-18	33.4	1.315"	152	6"
AHA-20	3/8-32	12.7	.500"	133.3	5.25"
2202007	9/32-40	9.14	.360"	51	2"
2202008	9/32-40	9.14	.360"	102	4"
2202009	10-32	9.14	.360"	102	4"
2201954	5/16-32	9.02	.355"	51	2"
2201963	5/16-32	9.02	.355"	102	4"
2201975*	3/8-32	9.5	.374"	61.7	2.43"

\* Use on 2204599

#### Accessories for High Magnification Systems — DP10/DP5



## Dimensionair® Air Rings

Air rings are supplied in several styles for external measuring. Two and three jet rings are most common, used for checking outside diameters for sizes out of round conditions from 6.3 mm / .248" to 63.5 mm / 2.500". Four and six jet rings are also available for special applications. All Air Rings have chrome-plated wear surfaces unless otherwise specified.

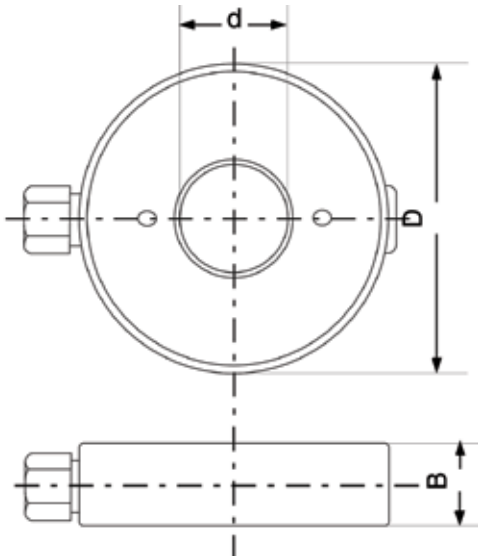

Jet air ring gage with 2 measuring jets

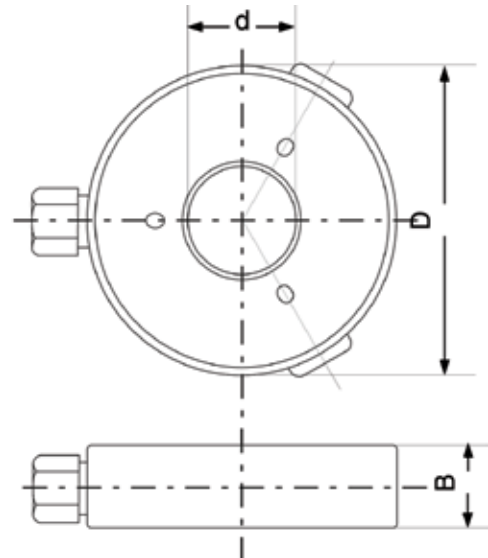

Jet air ring gage with 3 measuring jets

For applications where O.D.'s need to be checked near a shoulder, or where part length is restricted, contact Mahr Federal for technical assistance about shoulder and Snout Type Air Rings.

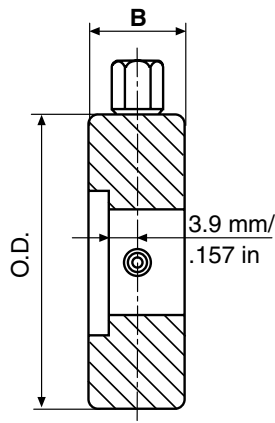

Counterbore Type

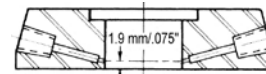

Shoulder Type  
(for 2500:1 & 4000:1  
5000:1 & 8000:1 only)

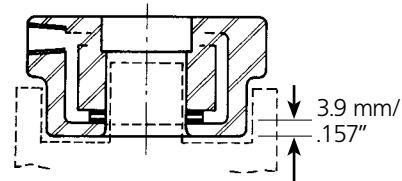

Snout Types

### Technical Data

Diameter d		Diameter D		Width B	
mm	inch	mm	inch	mm	inch
6.3-7.6	/.248-.299"	76.2	3.00"	25.4	1.00"
7.6-9.3	/.299-.366"	76.2	3.00"	25.4	1.00"
9.3-13.0	/.366-.512"	76.2	3.00"	25.4	1.00"
13.0-21.0	/.512-.827"	76.2	3.00"	25.4	1.00"
21.0-25.4	/.827-1.00"	76.2	3.00"	25.4	1.00"
25.4-38.4	/1.00-1.51"	101.6	4.00"	25.4	1.00"
38.4-44.5	/1.41-1.75"	101.6	4.00"	25.4	1.00"
44.5-50.8	/1.75-2.00"	127.0	5.00"	25.4	1.00"
50.8-63.5	/2.00-2.50"	127.0	5.00"	25.4	1.00"
63.5-76.2	/2.50-3.00"	139.7	5.50"	25.4	1.00"

When ordering ring gages, please specify the following:

- Nominal workpiece dimensions
- Tolerance
- Desired magnification
- Instrument used
- Setting plug to be supplied?

Air Rings may be attached directly to a Dimensionair or used on a base and connected to the gage with a plastic hose. Vee type Guide Chutes can be furnished on one or both sides if Air Rings from 6.3 mm / .248" through 44.5 mm / 1.750". Tube type guide can be furnished on sizes from 6.3 mm / .248" through 63.5 mm / 2.500".

## Dimensionair® Air Rings

### Options for Air Rings

#### Carbide Wear strips

Air plugs are normally furnished chromed for long life. Other materials can be provided to improve the life of the ring when high volume or grinding grit may still remain on the part. Materials such as Ferrotic and addition of carbide strips can be provided.

#### Bases for air rings

Depending on the application there are many ways to hold an air ring. They may be hand held and placed over the part if the part is still on the machine. They may be front mounted, horizontally or vertically on the Dimensionair or for larger parts they can be mounted to a base and held vertically or horizontally.

Special bases are available to mount the ring horizontally and incorporate a part lifting mechanism to aid in part removal.

#### Guide chutes

Guide chutes and vees are available in a host of options to improve the inspection process. Vee type guide chutes can be furnished on one or both sides of an air ring from 6.3 mm / **.248"** through 44.5 mm / **1.75"**. Other options include tube type guide chutes for sizes 6.3 mm / **.248"** through 63.5 mm / **2.5"**.

Standard length of the guide chutes are 63.5 mm / **2.5"** and affix to the side of the air ring. Normal length of the chute is 63.5 mm / **2.5"**. Other options including heavy duty out riggers and universal vee stands can be provided.



### Options for Air Snaps

Since side clearances can present gaging problems with crankshaft diameters or similar applications, Mahr Federal designed a new line of air snaps that make the tough measurements easier and affordable.

We based our new air snap design on our own proven air tooling techniques, known for providing long life and high-resolution in tough shop environments. Now you can measure fixed sizes from 12.5 mm / **.49"** through 184 mm / **7.25"** using D-2500 and D-5000 systems. Widths are typically 19 mm / **.75"** but can be customized to reach diameters having tight clearances.

Jet locations can be located central in the snap or positioned close to either side for exploring close to a shoulder.

Multiple circuit air snaps are available for speeding the process while checking the journal for size variation, taper, barrel or hourglass shape.





## Dimensionair® Air Gages

### AirProbes and JetProbes

- AirProbes and JetProbes provide modular, convenient gage heads for use in hand-held gages and for designing into fixture gages.
- 9.5 mm / .375" bodies provide standardized mounting configurations.
- Compact size allows easy access to hard-to-reach dimensions.
- AirProbes and JetProbes are calibrated for instant use with Dimensionair® systems - just set zero and measure!
- Available in single-probe and matched-probe configurations.



AA-1-3 AirProbe and AAT-19 JetProbe Assembly

### AirProbes

For use where contact-type measurement is required with 2500:1 Dimensionair Systems. AirProbes are available in Regular Action (counter-clockwise meter movement when spindle is depressed) or Reverse Action (clockwise meter movement when spindle is depressed) and in various ranges. When used with Model 2500:1 Dimensionair, the Meter Dial must be specified to match the

AirProbe range (see table below). AirProbe and Dial are color coded - just match the color band on the AirProbe to the colored dot on the Dial to be sure that the AirProbe range matches the readout on the Dimensionair. AirProbes are provided with AAD-55 Straight Adaptor for attaching to Air Hoses.

Order no.	Range		Style / Color Code***	Matching Dial Model		Graduations	
	mm	inch		inch	metric	µm	inch
AA-1-3*	0.076	.003"	Regular / Red	ADL-28**	ADL-95**	1	.00005"
AA-2-3*	0.076	.003"	Reverse / Red	ADL-28**	ADL-95**	1	.00005"
AA-1-6	0.152	.006"	Regular / Green	ADL-16	ADL-96	2	.0001"
AA-2-6	0.152	.006"	Reverse / Green	ADL-16	ADL-96	2	.0001"
AA-1-30	0.762	.030"	Regular / Blue	ADL-24	ADL-98	10	.0005"
AA-2-30	0.762	.030"	Reverse / Blue	ADL-24	ADL-98	10	.0005"

\* .003" Range AirProbes can also be used with 5000:1 Dimensionairs, but the working range is reduced to .0015".

\*\* These dials are the same as normally supplied on 2500:1 Dimensionairs, except for the color code.

\*\*\* Regular AirProbes have single color band; reverse AirProbes have double color band.

AirProbes can be supplied in matched pairs, either two Regular Action AirProbes or one Regular and one Reverse Action AirProbe. Contact Mahr Federal Customer Resource Center to specify.

### AirProbes JetProbes

JetProbes are similar to AirProbes, except they have an open jet at the end, instead of a contacting spindle. JetProbes are ideal for measuring flatness of surfaces which cannot be touched, or for building into fixture designs where air gaging is called for. JetProbes can be used with 2500:1, 5000:1 Dimensionairs, and are supplied

singly or in matched pairs. **Order no. AAT-19** for single JetProbe or **AAT-20** for a matched pair. JetProbes are supplied with AHO-1 Air Hose, a zero setting valve, and hardware for mounting to the Dimensionair.

## Air Gaging Accessories

### Magnification Kits

Magnification Kits provide a means for checking Amplifier accuracy, traceable to the National Institute of Standards and Technology (NIST). Each Kit contains restrictors that provide pressure characteristics at zero and at both ends of the scale, a calibrated dial diagram and a Certification of Calibration.

Order no.	For use with:	Tooling
<b>AMR-SPEC-136</b>	1250:1	DP/DR100
<b>2094182</b>	1260:1	DP/DR60
<b>AMR-12</b>	2500:1/4000:1	DP/DR50
<b>AMR-13</b>	5000:1/8000:1	DP/DR20
<b>AMR-14</b>	10000:1/16000:1	DP/DR10
<b>AMR-15</b>	20000:1/32000:1	DP/DR5



**AMR-12**

### Manifolds

Manifolds allow connecting multiple pieces of air tooling to one Dimensionair. Toggle valves allow activation of the selected tool. Manifolds are compatible with Dimensionairs 1250:1 through 8000:1M Manifolds for use with other Dimensionairs, contact Mahr Federal Customer Resource Center – **1-800-333-4243**.

Order no.	Description
<b>2248282</b>	2-way Manifold
<b>2248283</b>	3-way Manifold
<b>2248284</b>	4-way Manifold
<b>2248285</b>	5-way Manifold

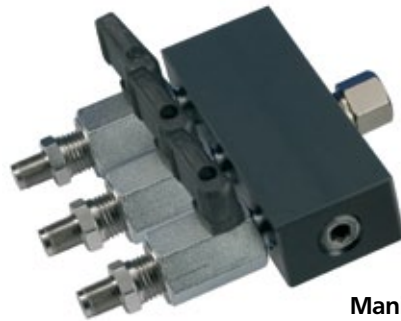

**Manifold 2248283**

### Hoses

Supply hoses and hoses between Dimensionair and air tooling.

Order no.	Description	Thread
<b>AHO-2</b>	1.5 m / 5 ft Air Supply Hose. Fits all Dimensionair models. (rubber)	7/16-20
<b>AHO-1</b>	0.9 m / 3 ft Air hose for tooling for Models 1250:1 – 8000:1. (Tygon)	3/8-32
<b>AHO-8</b>	1.5 m / 5 ft Air hose for tooling on Models 1250:1 – 8000:1. (Tygon)	3/8-32
<b>AHO-10</b>	1.8 m / 6 ft Air hose for Models 1250:1 – 8000:1. (Tygon)	3/8-32
<b>AHO-20</b>	0.9 m / 3 ft Air hose for tooling on Models 10000:1 – 32000:1. (Tygon)	9/32-40
<b>ARG-1</b>	Replacement O-ring for AHO-1, -8, -10 Hoses and AHA-4, -5, -6, -20 Handles.	
<b>ARG-6</b>	Replacement O-ring for AHO-20 Hose, AHA-23 and -24 Handles.	
<b>ARG-10</b>	For AEX-1, AEX-2 and AHA-28	

### Traps and Filters

Good gaging practice requires clean, dry air for gage performance. Dimensionair Models are furnished with a particle filter. Shop air contains water and oil, which should be removed, using Model **AFL-24** Oil and Water Separator Trap.

Order no.	Description
<b>AFL-10</b>	Particle Filter (normally furnished on all Dimensionair Models). Filter size: 5 microns; Maximum pressure: 250 p.s.i.; maximum working temperature: 175°F.
<b>AFL-24</b>	Oil and Water Separator Trap, includes mounting hardware. Filtering capacity: 99.7% removal of oil and water; filter size: 3-6 microns; maximum pressure: 150 p.s.i.; flow rate: 20 cubic feet of air/minute @ 80 p.s.i.
<b>AFL-23</b>	Replacement cartridge for AFL-24.
<b>AFL-21</b>	Replacement cartridge for AFL-10.



**AFL-24 Trap**

## Millimar. Standard Elements



### Modular

The use of **Millimar** standard elements allows multi-gage measuring devices to be designed and implemented for the widest possible range of workpieces, e.g. rotationally symmetrical and non-rotationally symmetrical parts.

Rotationally symmetrical workpieces can be mounted between centers or on prismatic supports, whereas non-rotationally symmetrical workpieces often require a special holder.

### Versatile

The versatility of the **Millimar** standard elements means that the right solution can be provided, whatever the measurement task at hand.

Whether it's a question of external, internal or length measurements, the **Millimar** standard elements will be able to meet your requirements, even in the case of complex workpiece geometries.

Thanks to the space-saving design of the styli, a high number of measuring points can be inspected within a small area of the testpiece.

The pneumatic lifting mechanisms integrated into the measuring elements simplify the job of moving the testpiece into the measuring position and reduce the amount of wear on the styli.

### Flexible

The modular concept using **Millimar** standard elements is continued throughout the construction of the whole system. A generous amount of travel in the styli (up to 20 mm / 0.79") allows a high degree of flexibility in terms of the variety of testpieces that can be accommodated.

### Precise

The **Millimar** standard elements are specially designed for use in the workshop and are manufactured using a rigorous process. This guarantees that the measuring devices give stable and reliable measurements.

For example, using styli fitted with two ball-bearing guides for supporting the moving part, it is possible to achieve measurement accuracy at the  $\mu\text{m}$  scale, if this is required due to the tolerances of the feature being measured.

### Reliable

All components are long-lasting and low-maintenance thanks to the use of rust-proof materials, the selection of appropriate heat treatments, and the use of a lifting mechanism to minimize the effects of friction acting on the styli when the workpiece is inserted.

### Economical

Our systems can either be constructed by the customer from standard elements obtained from the catalogue, or alternatively we can provide ready-built devices as turn-key solutions. Whichever option you choose, you can be sure that you are purchasing a system that is tailored to your specific requirements on the most favorable of terms.

Below are just a few examples of the many factors that contribute to the cost effectiveness of the **Millimar** standard elements:

- Reusability of standard elements: Once manufacture of a particular type of workpiece has ceased, all standard elements used in the test equipment can be reused for a different type of workpiece.
- A choice of different mechanisms for guiding the moving part of the stylus, according to the accuracy requirements of the measuring task (optimal price-performance ratio).
- Reduction in development and implementation time.
- Availability of the equipment: Our standard elements are manufactured under standard production conditions and are always available off the shelf and ready to use.

Gage module  
Travel distance: 5 - 10 - 20 mm

XY tables  
Travel distance: 2.5 - 5 - 7 mm

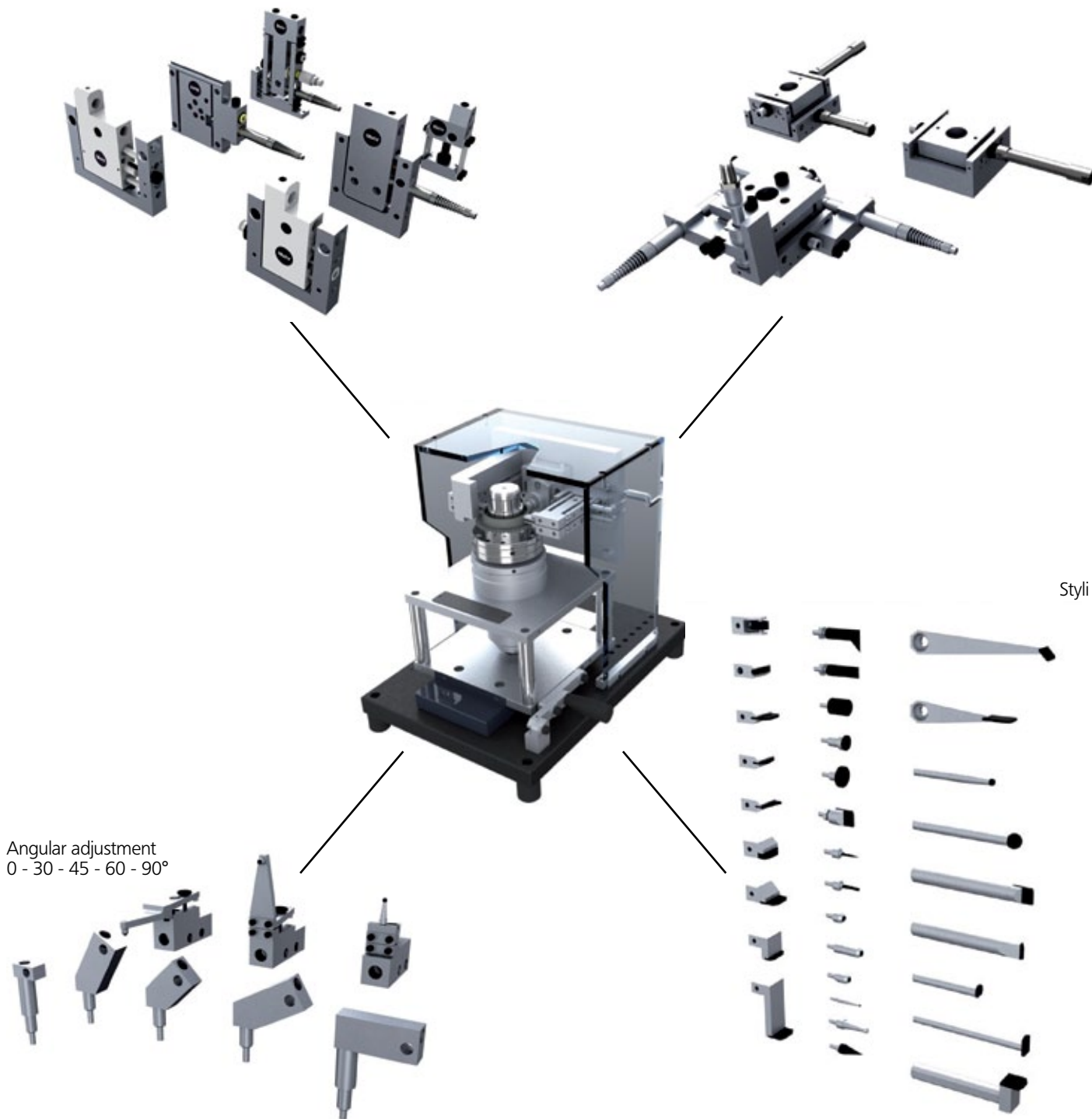

Angular adjustment  
0 - 30 - 45 - 60 - 90°

Styli



For further Information please refer to Chapter 20 - MarSolution  
If you require more detailed Information please consult our Millimar  
Components Catalog, [www.mahr.com](http://www.mahr.com), Webcode 153 or  
Visit our Mahr Online Product Catalog under <https://eshop.mahr.com>